



Image for demonstration purposes

 **Generating Set**
SUPERSILENT - Diesel

GE.VO.150/135.SS+011

1500 rpm - Threephase - 50Hz - 400V
Automatic panel without switching on board



Standard equipment

Canopy Soundproofing

- Removable soundproof canopy
- Painting canopy (RAL) in galvanized sheet steel
- Soundproofing with class 1 polyester material
- Handles with key lock and automatic closing
- Special baffles for air intake and air expulsion
- Inspection doors for controls and maintenance

Exhaust

- Exhaust rain cap
- Exhaust manifold protection
- Insulated exhaust pipes
- Internal residential muffler - 35dB(A)

Fuel Supply

- Single wall daily tank with bunded base
- Automatic shutdown system for low fuel level
- Fuel gauge

Handling

- Lifting hook integrated into the bearing structure
- Base frame with anti-overturning forklift pockets

Base Frame

- Bunded base at 110% of fuel tank capacity
- Anti-vibrating mounting pads
- Battery compartment externally accessible for easy service

Engine

- Engine pre-heater 230V
- High coolant temperature and low oil pressure shutdown system
- Oil pressure and coolant temperature gauge (only with QPE or +14 variant)
- External oil drain points
- Engine liquids (oil and antifreeze)
- Tropicalized radiator
- Rotating parts protection
- Electronic speed governor
- Radiator level sensor

Alternator

- AVR Automatic Voltage Regulator
- Impregnation for marine environment
- IP23

Panel & connection

- Emergency Stop button
- Non-Automatic circuit breaker on panel board
- Tamperproof panel IP55
- Cable output from side
- IP44 wiring
- Start-up battery (pre-charged)
- Grounding point

Documentation

- CE conformity declaration
- User and Maintenance manual
- Wiring diagrams

Normatives

- All Generating sets are compliant to CE Marking
- 2014/30/UE Electromagnetic compatibility
- 2000/14/CE Noise Emission for outdoor use
- Factory-designed systems built according to ISO 9001:2015
- CEI EN 60204-1:2018 - Electrical equipment of machines

Primary data

General Information

| | | |
|---------------------------------|-----|---------|
| Speed | RPM | 1500 |
| Frequency | Hz | 50 |
| PRP | KVA | 130 |
| PRP - Prime power | KW | 104,0 |
| LTP - Standby power | KVA | 144 |
| LTP - Standby power | KW | 115,2 |
| Standard Voltage | V | 400/230 |
| Current | A | 187,86 |
| Voltage for current calculation | V | 400 |
| COSFI | 0,8 | 0,8 |

General electrical protection

| | | |
|--------------------------------|--|-----|
| Circuit-breaker rated current | A | 250 |
| Type | Non-Automatic circuit breaker on panel board | |
| Circuit-breaker poles | N | 4P |
| Optional/notes circuit-breaker | Opening coil | |

Noise level +/- 3dB(A)

| | | |
|-----------------------------|-------|----|
| LWA | dB(A) | 91 |
| Sound pressure level @ 7 mt | dB(A) | 66 |
| Sound pressure level @ 1 mt | dB(A) | 75 |

Fuel Consumption

| TYPE | | Diesel |
|-------------------------------|------|--------|
| Standard Fuel Tank capacity | lt | 400 |
| Autonomy @ 75% load | h | 20 |
| Fuel consumption at 100% load | lt/h | 28,4 |
| Fuel consumption at 75% load | lt/h | 20,9 |
| Fuel consumption at 50% load | lt/h | 14,1 |

General data

| | | |
|-------------------------|------|-------|
| Rated capacity | Ah | 1x120 |
| Auxiliary Voltage | V | 12 |
| Exhaust gas temperature | °C | 507 |
| Exhaust gas flow | l/s | 353 |
| Combustion air flow | l/s | 125,8 |
| Cooling fan airflow | mc/s | 3 |
| Exhaust diameter | mm | 100 |
| Exhaust side | | DX |

Weight and Dimensions

| | | |
|--|------------|-------------|
| Dimensions (L x w x h) | cm | 340x120x195 |
| Weight with liquids (excluding optionals and fuel) | Kg (+/-3%) | 2233 |

Engine

| | | |
|------------------------|------|---------------------------------------|
| Factory | | Volvo |
| Model | | TAD 532 GE |
| Emissions stage | | Stage 2 |
| Speed governor | | Electronic |
| Radiator | °C | 50 |
| Cooling | Tipo | liquid (water + 50% Paraflu11) |
| Active net power | Kwm | 112 |
| Nominal net power | CV | 152,2 |
| Cycle | Tipo | 4 strokes |
| Injection | Tipo | Direct |
| Aspiration | Tipo | Turbo |
| Numbers of cylinders | N | 4 |
| Cylinders arrangement | | L |
| Bore | mm | 108 |
| Stroke | mm | 130 |
| Total displacement | lt | 4,761 |
| Engine oil features | | 15W40-API CI-4/CH-4 ACEA E5-E7 |
| Total oil capacity | lt | 13 |
| Total coolant capacity | lt | 18 |
| ISO 8528-5 class | | G3 |

Alternator

*** May vary based on stock availability. However, a primary brand will be used.**

| | | |
|--------------------------------------|-------|------------------------------|
| Factory | | Stamford |
| Model | | UCI274E |
| Single-phase Range | KVA | 140 |
| Voltage Regulator (voltage accuracy) | +/- % | 1 |
| Poles | N° | 4 |
| Phases | N° | 3+N |
| Standard windings connection | | Star Series |
| Stator/rotor impregnation | | H (Outdoor Temp 40°C) |
| Efficiency | % | 91,7 |
| Engine coupling | | Elastic disk |
| Short circuit current | | >= 300% (3In) |
| Protection degree | IP | 23 |
| Cooling system | | Self ventilating |
| Maxium overspeed | rpm | 2250 |
| Waveform distortion | % | <5 |
| Exciter | | Diode bridge |

Standard operating environmental conditions

| | | |
|---------------------|----|-------------|
| Ambient temperature | °C | 25 |
| Relative Humidity | % | 30 |
| Max altitude | mt | 1000 |

Control Systems on board QPE-C-SC-3F-4P-250-O3



operating scheme - schema di funzionamento

QPE Automatic panel without switching on board

The QPE-C control panel represents the evolution of the panel for the control and management of the gen set. With its microprocessor logic it is able to meet any user requested features. The dual operation mode manual and automatic guarantees to every type of functionality protection, analysis and control of the generating set in order to make the management easy and efficient. Variant without transfer switch on board. ATS panel type QC as optional. The panel manages the QC panels directly or any other ATS panel.

Mechanical features

| | | |
|-------------------|----|----|
| Protection degree | IP | 55 |
|-------------------|----|----|

Battery charger

| | | |
|--------------------------------|-----------------|-------------|
| Model | | ELCOS - CB1 |
| Maximum output current | A | 2,5 |
| Output DC voltage (selectable) | V _{dc} | 12-24 |
| Input AC voltage (selectable) | V _{ac} | 220-260 |
| Frequency | Hz | 50-60 |

Data Communication

| | | |
|------------------------|--|-----------------|
| Data connection port | | RS-485 |
| Communication protocol | | Mod-bus RTU-8N1 |

Remotable functions in terminal box

| | |
|--|--|
| GS start | GS lock |
| Genset contactor close/open command (1) | Mains contactor close/open command (2) |
| Common Alarm - DC output | GS test without load |
| GS start with key in OFF position (Only in MRS mode) | Programmable output - Volt free output |

(1) Ready to load function (MRS mode only)(2) AMF mode only

Control Module



| | |
|----------------|-----------|
| Model | MC4 |
| Operating mode | AMF - MRS |

Specifics

Applications

Emergency to the Mains
Stand-alone
Construction site/Rental
Self-production

ENGINE MEASURES

Fuel tank level %
Engine oil pressure BAR (1)
Engine Coolant temperature °C (1)
Total run time
Partial run time
Hours to maintenance
Battery voltage
Battery charging voltage
Start-ups counter
Engine speed (2)
Engine Oil temperature (2)
Cooler temperature (2)
Engine oil level (2)
Engine coolant level (2)
Engine coolant pressure (2)
Turbo pressure (2)
Fuel Consumption (2)
Tank autonomy - hrs (5)
Fuel remaining quantity (5)
Fuel used quantity (5)

ALTERNATOR MEASURES

Generator Voltage L1, L2, L3
Generator Voltage L1-N, L2-N, L3-N
Generator frequency
Generator current L1, L2, L3
Generator Apparent Power kVA
Generator Active Power kW
Generator Reactive Power kVAR
Generator accumulated power kWh
Power factor Cosfi

MAINS MEASURES

Mains voltage L1, L2, L3
Mains voltage L1-N, L2-N, L3-N
Mains frequency

COMMUNICATION PORTS

Can-bus port
RS485 port with Mod-bus RTU communication
RS232 port for display connection
USB port for parameters saving and firmware update

EQUIPMENT

Microprocessor Logic
Back-lit display
Programmable from display
16 event log
Multiple display languages
STOP button
START button
TEST button
Reset alarm button
Alarm mute button
Fuel transfer pump activation button
Glow-plug activation button

PRE-ALARMS/ ALARMS

Common Alarm
Fuel reserve (pre-alarm)
Low fuel level (alarm)
Tank overflow
Charge alternator failed (dinamo)
Low oil pressure (pre-alarm) (1)
Low oil pressure (alarm)
Oil sensor failed (alarm)
High coolant temperature (pre-alarm) (1)
High coolant temperature (alarm)
Low coolant temperature (pre-alarm)
Low water level (1)
Water in fuel (1)
Battery undervoltage
Battery overvoltage
GS failure to start
GS failure to stop
Can-bus Failure
No Can-bus communication
Genset overload L1, L2, L3 phases
Genset short circuit
Genset overvoltage
Genset undervoltage
Genset high frequency
Genset low frequency
overspeed
Reverse power
Earth fault (pre-alarm)
Earth fault (alarm)
Block from password
CAN communication Failed
Maintenance request
Emergency button pressed
Remote emergency active
Forced stop
External battery failed
Fuel theft
Genset negative phase sequence
Mains negative phase sequence
Fuel theft protection

VISUALIZATIONS ON CONTROL MODULE/DISPLAY

Pre-alarms
Alarms
Engine measures
Alternator measures
Mains measures
Date and time
Operating mode
Genset status
Mains status
Mains contactor status
Genset contactor status
Digital Input and Output status
Grounding current mA (3)
Grounding current threshold mA (3)
Delay time of differential protection (3)
Glow plugs status

CONTROL MODULE FUNCTIONS

Automatic start and stop when the Mains Fails (7)
Remote Start and Stop
Remote Start and Stop with key in OFF position
Manual Start and stop
Emergency stop button on panel board
Remote emergency stop
Remote lock
Remote test without load
Remote test on load
Scheduled start-ups
MODBUS commands (Start, Stop, Reset, Test)

CONTROL MODULE SPECIAL FUNCTIONS (on demand)

Automatic charging of an external battery
Dummy load (4)
Load shedding (4)
Redundant starter motor management
Fuel monitoring
GS battery Load test
Idle mode
Service phone number indication
Variable speed Generator
Master / Slave mode

- (1) Present with the sensor installed on engine
- (2) Present according to the engine equipment and to the ECU type (ECU - Canbus)
- (3) Present only with the residual current device mounted on genset board
- (4) Present with optional expansion modules
- (5) Present with special function activated
- (6) Only with the optional of the automatic fuel refilling system on board
- (7) Only in AMF mode

AAABBB

OPTIONAL

Fuel Supply

**O.G-ACO-AT-C3V-02**

External fuel tank connections with 3-way valve for supply from internal or external tank (130/700 kVA)

**O.G-ACO-AT-C3V-AR-02**

Quick coupling connectors with 3-way valve for internal or external fuel tank connection (130/700 kVA)

**O.G-ACO-AT-CI-02**

External tank connections for supply only from external tank (g without tank) GE 130/700

O.G-ACO-BT-C3400-1000

1000 Lt Oversized Fuel Tank on board for SS, RB (130/150 kVA)

O.G-ACO-BT-C3400-1500

1500 Lt Oversized Fuel Tank on board for SS, RB (130/150 kVA)

**O.G-ACO-GA-01**

Mechanical analogue float for internal fuel tank on board

**O.G-ACO-GA-02**

Electrical analogue float to monitor the external refilling point on board

**O.G-ACO-RE-01**

External refilling point for Gen Sets 10/250 kVA, SS, RB versions

**O.G-ACO-RE-SP-01**

External refilling point with warning light for Gen Sets 10/250 kVA, SS, RB versions

**O.G-ACO-SP-01**

Tank leak sensor with signal reported in the QPE control panel

**O.G-ACO-ST-2P**

Double redundant electric pump kit for automatic fuel refilling system

**O.G-ACO-ST-BG-ES1**

"Easy" automatic fuel refilling system on board, controlled by QPE-C and QLE-B panels

O.G-ACO-ST-BG-HDT

"Heavy Duty" automatic fuel refilling system on board, controlled by QPE-C and QLE-B panels

**O.G-ACO-ST-BG-STD**

"Standard" automatic fuel refilling system on board, controlled by QPE-C and QLE-B panels

Alternator

O.G-ALT-AL-CHBR-03

Different brand alternator 130/250 kVA (Check dimensions)

**O.G-ALT-AL-COTE-01**

Temperature control unit up to 4 x PT100 probes for MC4 management

O.G-ALT-ST-ACO-01

Anti-condensation heater 230 V (on Stamford from 80 to 2000 kVA)

O.G-ALT-ST-AVR-MX321

Stamford MX321 automatic voltage regulator with PMG (Check dimensions)

O.G-ALT-ST-AVR-MX341

Stamford MX341 automatic voltage regulator with PMG (Check dimensions)

O.G-ALT-ST-PT100-1CU

1 x PT100 probe on bearing (80/3000 kVA)

O.G-ALT-ST-PT100-3AV

nr. 3 RTD-PT100 probes on stator windings (80/3000 kVA)

O.G-ALT-ST-PT100-6AV

nr. 3+3 RTD-PT100 probes on stator windings (80/3000 kVA)

O.G-ALT-ST-RIGU-01

Diode Failure Detector (DFD) mounted on the alternator. Alarm contact available into the panel

 **Batteries**

O.G-BAT-BAE-03

Maintenance free high efficiency starter batteries (130/250 kVA)

O.G-BAT-DOB-02

Redundant battery kit for Gen Sets 130/250 kVA

O.G-BAT-STB-02

Battery isolator lockable(130/700 kVA)

 **Canopy**

O.G-COF-AM-01

Hinges and Doors with tamper-proof device (10/100 kVA)

O.G-COF-AP-01

Door opening alarm system (each door)

O.G-COF-C3400-INOX

Additional cost for stainless steel canopy (C3400)

O.G-COF-CA-C3400

IP 43 Conveyors for Gen Sets 130/150 kVA - supplied disassembled

O.G-COF-CH-05

Additional cost for larger canopy C3600 instead of standard C3200 - Dim. cm 360x130x205H - Fuel tank 450 lt

O.G-COF-DI-C3400

Double soundproofing -2 dBA at 7 mt. (130/150 kVA) including IP43 conveyors (provided disassembled)

O.G-COF-DLO-C3400-45KW

Dummy Load 45kW on board for Gen Sets 130/150 kVA

O.G-COF-EAF-04

Frontal air expulsion for Gen Sets 130/150 kVA (C3200) (change the noise level)

O.G-COF-FP-02

Door stop (130/1000 kVA)

O.G-COF-IL-01

Internal LED lighting with micro-switches for Gen Sets 10/250 kVA

O.G-COF-PV-02

Lift off doors kit for SS versione (130/400 kVA) and PRO version (130/500 KVA)

O.G-COF-TRT-MAR-03

High resistance canopy treatment for corrosive environments for 130/250 kVA (SS, RB Versions)

O.G-COF-VER-PAR-03

Canopy custom paint (Grey base-frame) for 130/250 kVA (SS, RB Versions)

O.G-COF-VER-TOT-03

Total canopy custom paint for 130/250 kVA (SS, RB Versions)

⚙️ Electrical on board

O.G-USP-AR-250

Powerlock connector 250 A on board for SS Version

O.G-USP-BR-03

Copper bars for MCCB terminal box extension (130/250 kVA) SS Version

O.G-USP-MO-03

Terminal box inside the cable entry compartment for Gen Sets 130/250 kVA SS Version

O.G-USP-MPRB-03

RB module with 5 sockets, 1 plug and power cable access for GE from 130 to 250 KVA SS version (check feasibility)

O.G-USP-SW-MOT.0130-0250

Motorization switch on board machine, integrated in the panel for 130/250 Kva Ge - (for variant +11)

O.Q-QBM-BMIN-230V-02

Additional price for 230V minimum voltage coil on MCCB both on the control panel and on the alternator (check feasibility)

O.Q-QBM-CPI-BEN-01

Permanent insulation controller for IT networks up to 230V / 400V. BENDER IR423-D4-1. Adjustable threshold 10 ÷ 300 kohm. (2 DIN rail modules - check feasibility)

O.Q-QLE-K-DIF-M3

Adjustable differential protection only for MC2-PLUS controller for Gen Sets 10/500 kVA (+011 variant)

O.Q-QPA-COM-GC200

Option with COMAP GC200 controller on board instead of DSE 8610.

O.Q-QPA-COM-GC500

Option with COMAP GC500 controller on board instead of DSE 8610.

O.Q-QPA-COM-INTEL















Option with COMAP INTELIGEN controller on board instead of DSE 8610.

O.Q-QPA-LOV-RGK900

Option with LOVATO RGK900 controller on board instead of DSE 8610.

O.Q-QPE-485.CONV-LAN

Converter 485/LAN for QPE-C, QLE-B panel

| | | |
|---|------------------------------|---|
|  | O.Q-QPE-485.CONV-USB | Converter 485/USB for QPE panel |
| | O.Q-QPE-DIS-MS-01 | MASTER/SLAVE device for QPE panel |
| | O.Q-QPE-INT-CST-03 | STATUS contact GE main switch wired to terminal board inside the QPE panel (130 / 250KVA) on board the GENERATOR. |
| | O.Q-QPE-K-DIF | Differential protection adjustable for the MC4 |
| | O.Q-QPE-MD-QPE-C | GSM remote management modem for QPE panel |
|  | O.Q-QPE-POT-VOLT | Internal potentiometer for voltage regulation - available only for variant +10/+11 |
|  | O.Q-QPE-PR-QPE-C | Remote panel for QPE-C, QLE-B - available only for variant +10/+11 |
|  | O.Q-QPE-QBM-COM-AMF25 | Option with QBM COMAP AMF25 controller on board instead of QPE |
|  | O.Q-QPE-QBM-DSE-7320 | Option with QBM DSE7320 controller on board instead of QPE. |
|  | O.Q-QPE-RIL-16RELE | 16-relay module for QPE panel |
|  | O.Q-QPE-RX8-QPE-C | Start-stop radio control with max. radius 500 mt indoors and 5 km outdoors (for QPE panel). |
|  | O.Q-QPE-SAS-02 | Auto Start-Stop at load request (QPE, QLE panels) |
|  | O.Q-QPE-SCD-01 | Anti-condensation heater inside the panel |
|  | O.Q-QPE-SEL-50-60 | Switch selector 50Hz 400V / 60Hz 480V |
|  | O.Q-QPE-TG-EVO-GPS-2G | Remote management system via LAN/GSM 2G with WEB application and GPS location system |
|  | O.Q-QPE-TG-EVO-GPS-3G | Remote management system via LAN/GSM 3G with WEB application and GPS location system |
|  | O.Q-QPE-TG-QPE-C | Remote management software via LAN for QPE-C, QLE-B panel compatible with Windows XP and 7 |
|  Engine | | |
|  | O.G-MOT-FC-5 | Dust collector filter - for Gen Sets 130/150 kVA |

O.G-MOT-FSA-5

Fuel/Water Separator Filter - for Gen Sets 130/150 kVA

O.G-MOT-K-40C-03

Engine liquids suitable for -40°C ambient temperature for Gen Sets 130/250 kVA

O.G-MOT-MAG-01

Dual starter motor for Gen Sets 130/150 kVA (engine configuration to be checked)

O.G-MOT-PO-02

Oil change pump for Gen Sets 130/700 kVA

O.G-MOT-RF-02

Electronic speed governor for Gen Sets 50/200 kVA

O.G-MOT-SC-AC-EL-03

Super hot engine heater 230V with thermostat on board for Gen Sets 130/250 kVA

O.G-MOT-SC-AC-WE-02

Webasto diesel-operated water pre-heater (130/400 kVA)

O.G-MOT-SE-LR-02

Radiator coolant level sensor from 130 to 700 kVA

O.G-MOT-SRO-AU-30L

Automatic oil refilling system (130/250 kVA)

 **Handling**
O.G-MOV-CN-5

Off-road trailer with 2 pneumatic wheels and tow bar (SS, RB Gen Sets 130/250 kVA)

O.G-MOV-CO-ST-04

Roadworthy trailer 80km/h (130/150 kVA), registration excluded.

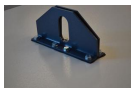
O.G-MOV-GC-BIG-01

Increased central lifting hook with 10x5cm hole (10/250 kVA SS version)

O.G-MOV-KRM-SS-03

Reinforcement kit for mobile installation (dedicated trailers or wheeled machinery) SS Version from 130 to 250 kVA

 **ATS Panels**

QC1.0250A

Separate ATS panel, ABB 250A motorized change-over (170 kVA 400V - 100 kVA 230V) Dim. 60 x 25 x 80 cm - 56 kg. (ex QC1.165)

QCP1.0250A

Separate ATS switching panel, with Lovato ATL 610 control unit, for variant +014, ABB motorized change-over 250A 4P (170kva 400V) and compartment for power cables inlet

QLTS.250A

Wall-mounted ATS switching panel 250A 4P (275 kVA 400V) Dim. 80 x 28 x 60 cm - 40 kg.

 **Exhaust**



O.G-SCA-CAT-05 Catalytic converter (130/250 kVA)



O.G-SCA-FAP-K150 Particulate filter (DPF) for Gen Sets 130/150 kVA



O.G-SCA-GF-80 Exhaust bellow with flexible joint including flange and counter flange (50/250 kVA)



O.G-SCA-PF-03 Spark arrestor for Gen Sets 130/250 kVA

Test



MS.CP-LT-02 FAT - Factory Acceptance Test for single Gen Set from 130 to 400 kVA according to our standard procedures in Elcos factory (max 2 hours - max 4 people - max 1 hour of operation)



MS.CP-SP-02 FAT - Factory Acceptance Test for single custom Gen Set from 130 to 400 kVA max 4 operating hours or parallel system up to 4 units for 1 operating hour, in Elcos factory (max 4 hours - max 4 people)



MS.CP-ST-02 FAT - Factory Acceptance Test for single Gen Set from 130 to 400 kVA according to our standard procedures in Elcos factory (max 4 hours - max 4 people - max 2 hour of operation)



MS.RF-ST-01 Noise test report for single Gen Set from 10 to 250 kVA



MS.TV-ST-01 Vibration test on 10 points with certificate for single Gen Set from 10 to 250 kVA

Vari



O.G-VAR-CAT-02 Toolbox for ordinary maintenance.

O.G-VAR-PUN-TER-01 Round earth spike, diam. 20 mm, height 1.5mt, galvanized, complete with clamp and 3m yellow/green cable model FS17 1x35mm² with cable lugs.

O.G-VAR-PUN-TER-02 Cross-shaped earth spike, height 1.5mt, galvanized, complete with clamp and 3m yellow/green cable model FS17 1x35mm² with cable lugs.



O.G-VAR-TPD-01 IP 55 document holder

PRP

Engines of this rating provide unlimited hours of usage in a variable load application. The average load factor should not exceed 70% of the engine's prime power rating with a maximum number of 500 operational hours at 100% prime power rating. An overload capability of 10% is available, however, is limited to a period of 1 in every 12 hours

LTP

Limited-time running power is defined as the maximum power available, under the agreed operating conditions, for which the generating set is capable of delivering for up to 500h of operation per year with the maintenance intervals. The overload is not allowed.

| | | | | | | | | | | |
|--------|--------|--------------|---------------|-------|----------|------|----|--------------|------------|----------|
| Sheet: | C 3400 | SUPER SILENT | Exhaust side: | Type: | STANDARD | Rev: | 02 | Last Update: | 22-05-2020 | Page 1/2 |
|--------|--------|--------------|---------------|-------|----------|------|----|--------------|------------|----------|

OVERALL DIMENSIONS [mm]

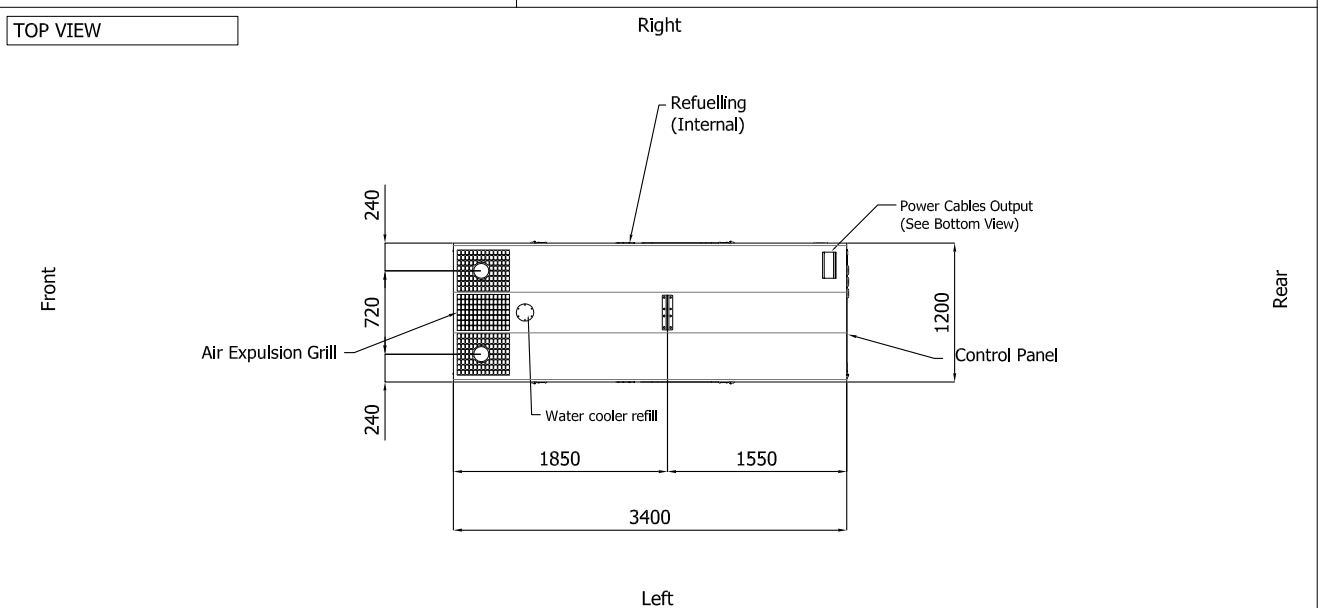
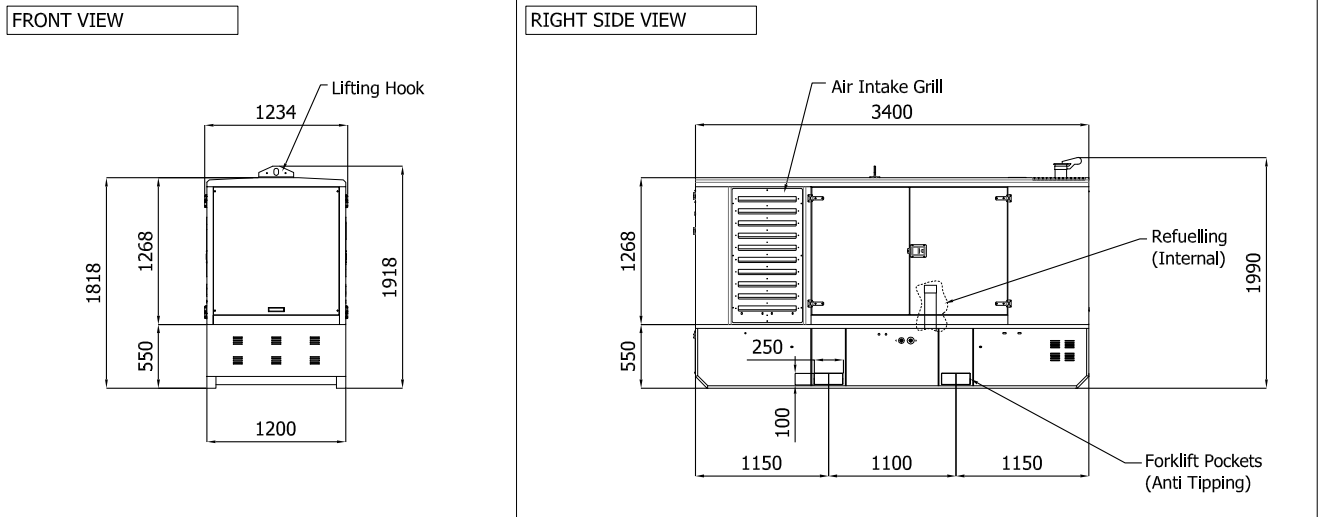
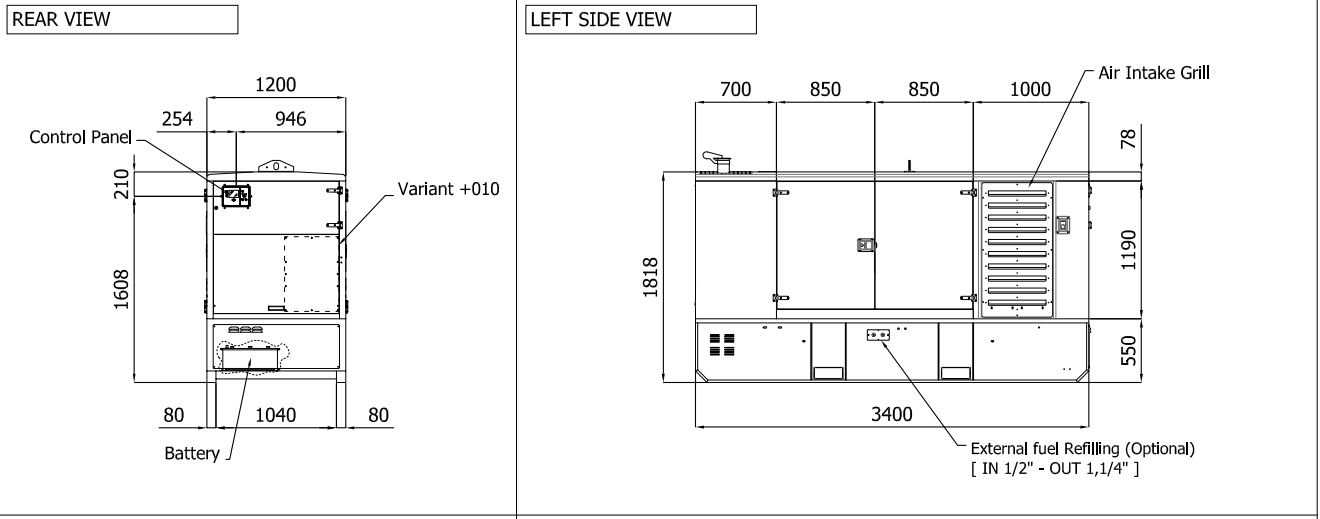

IMPORTANT:

- 1) Form and dimension refer to the generating set on catalogue
- 2) Form and dimension are subject to change in order to update or improve the products
- 3) This document can not be copied or transmitted without ELCOS S.r.l. approval

Data and technical specifications are subject to change in order to update or improve the products.

| | | | | | | | | | | | |
|--------|--------|--------------|---------------|--|-------|----------|------|----|--------------|------------|----------|
| Sheet: | C 3400 | SUPER SILENT | Exhaust side: | | Type: | STANDARD | Rev: | 02 | Last Update: | 22-05-2020 | Page 2/2 |
|--------|--------|--------------|---------------|--|-------|----------|------|----|--------------|------------|----------|

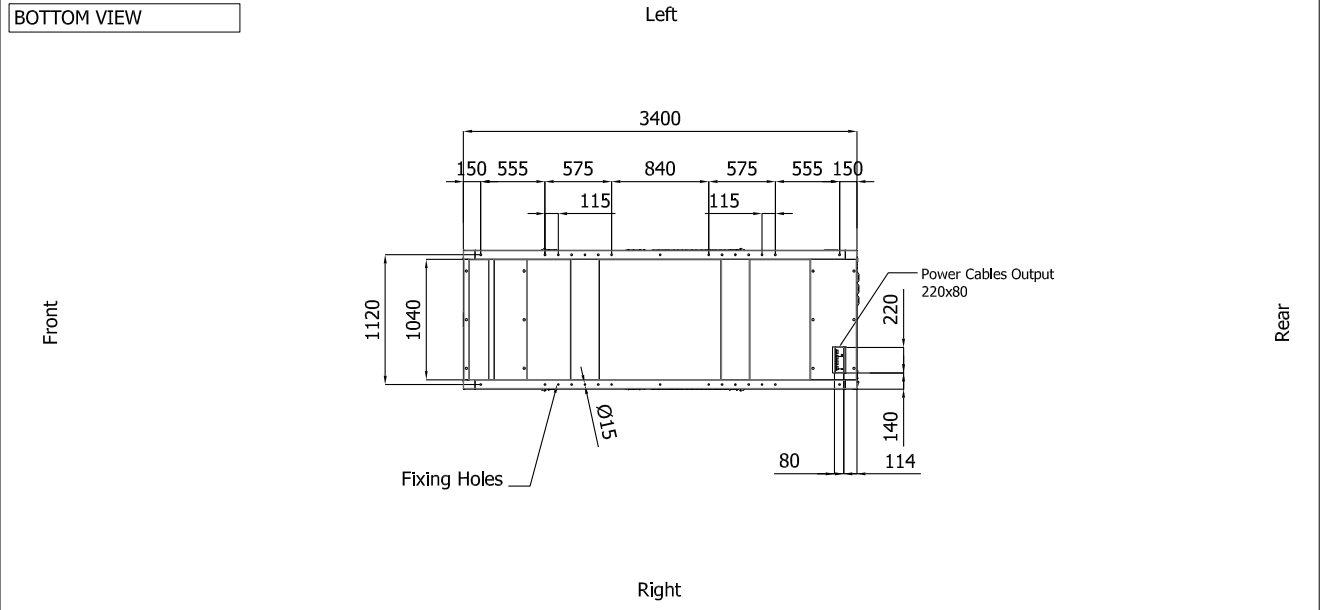

DIMENSIONS WITH OPEN DOORS [mm]

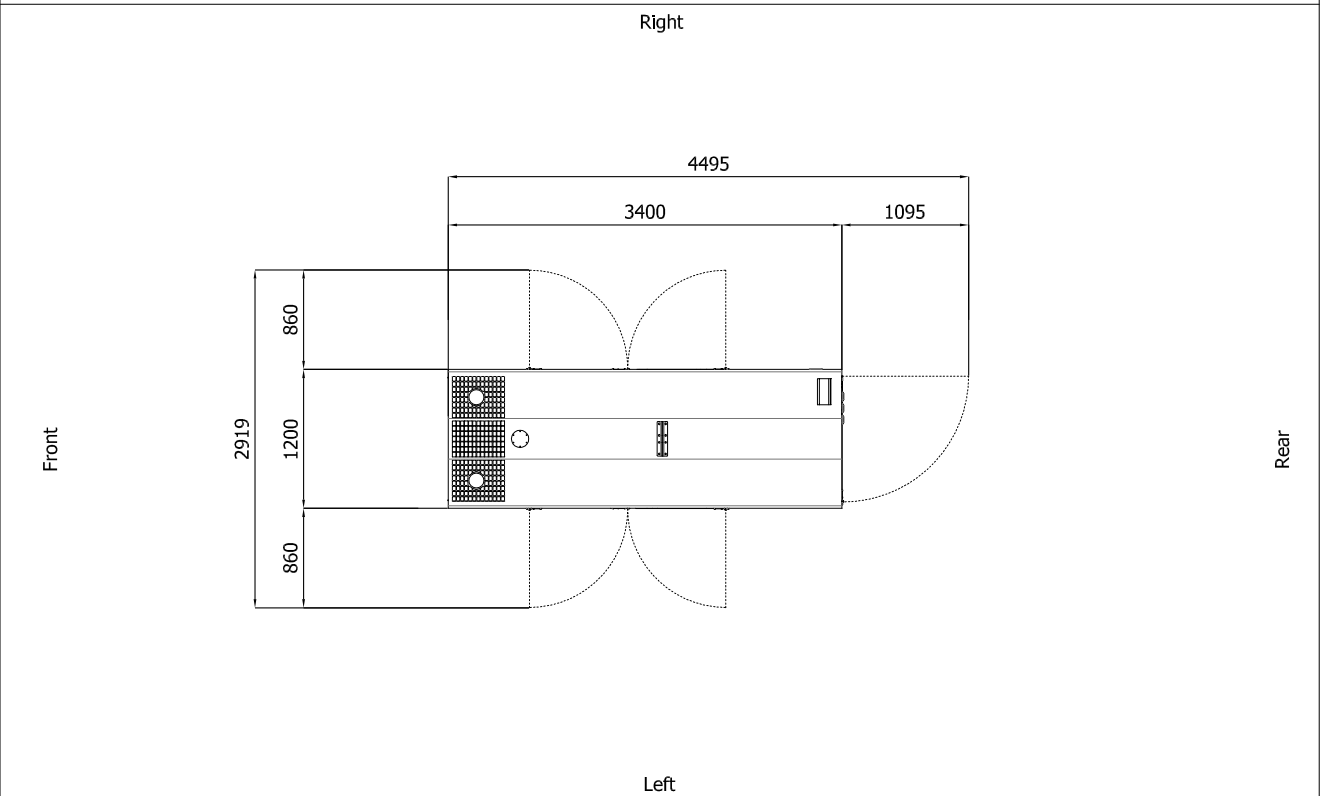

Note: With Lifting-Off Door Solution consider only canopy dimensions.
(Models with "Control Panel" behind rear door will mount a special cover to protect it)

VENTILATION OF THE ROOM

The windows area in the generating set room needs to be (recommended):
Aspiration: 1.25 m²
Expulsion: 0.85 m²
ATTENTION: for a correct ventilation the expulsion air and the exaust gas needs to be conveyed in the open-air

- IMPORTANT:**
- 1) Form and dimension refer to the generating set on catalogue
 - 2) Form and dimension are subject to change in order to update or improve the products
 - 3) This document can not be copied or trasmitted without ELCOS S.r.l. approval