



Image for demonstration purposes

 **Generating Set**
SUPERSILENT - Diesel

GE.PK.022/020.SS+011

1500 rpm - Threephase - 50Hz - 400V
Multifunction panel without switching on board



Standard equipment

Canopy Soundproofing

Removable soundproof canopy
Painting canopy (RAL) in galvanized sheet steel
Soundproofing with class 1 polyester material
Handles with key lock and automatic closing
Special baffles for air intake and air expulsion
Inspection doors for controls and maintenance

Exhaust

Exhaust rain cap
Insulated exhaust pipes
Internal residential muffler - 35dB(A)

Fuel Supply

Single wall daily tank with bunded base
Automatic shutdown system for low fuel level
Fuel gauge

Handling

Lifting hook integrated into the bearing structure
Base frame with anti-overturning forklift pockets
Reinforced base frame and crossbar for mobile use
forkliftable on the short side

Base Frame

Bunded base at 110% of fuel tank capacity
Anti-vibrating mounting pads
Battery compartment externally accessible for easy service

Engine

High coolant temperature and low oil pressure shutdown system
External oil drain points
Engine liquids (oil and antifreeze)
Tropicalized radiator
Rotating parts protection

Alternator

AVR Automatic Voltage Regulator
Impregnation for marine environment
IP23

Panel & connection

Emergency Stop button
Protection by controller
Tamperproof panel IP55
Cable output from the bottom
IP44 wiring
Start-up battery (pre-charged)
Grounding point

Documentation

CE conformity declaration
User and Maintenance manual
Wirings diagrams

Normatives

All Generating sets are compliant to CE Marking
2014/30/UE Electromagnetic compatibility
2000/14/CE Noise Emission for outdoor use
Factory-designed systems built according to ISO 9001:2015
CEI EN 60204-1:2018 - Electrical equipment of machines

Primary data

General Information

| | | |
|---------------------------------|-----|---------|
| Speed | RPM | 1500 |
| Frequency | Hz | 50 |
| PRP | KVA | 20 |
| PRP - Prime power | KW | 16,0 |
| LTP - Standby power | KVA | 22 |
| LTP - Standby power | KW | 16,8 |
| Standard Voltage | V | 400/230 |
| Current | A | 28,9 |
| Voltage for current calculation | V | 400 |
| COSFI | 0,8 | 0,8 |

General electrical protection

| | | |
|--------------------------------|---|--------------------------------------|
| Circuit-breaker rated current | A | 32 |
| Type | | Magnetothermal switch on panel board |
| Circuit-breaker poles | N | 4P |
| Optional/notes circuit-breaker | | Opening coil |

Noise level +/- 3dB(A)

| | | |
|-----------------------------|-------|----|
| LWA | dB(A) | 85 |
| Sound pressure level @ 7 mt | dB(A) | 60 |
| Sound pressure level @ 1 mt | dB(A) | 69 |

Fuel Consumption

| TYPE | | Diesel |
|-------------------------------|------|--------|
| Standard Fuel Tank capacity | lt | 110 |
| Autonomy @ 75% load | h | 28 |
| Fuel consumption at 100% load | lt/h | 5,3 |
| Fuel consumption at 75% load | lt/h | 4 |
| Fuel consumption at 50% load | lt/h | 2,9 |

General data

| | | |
|-------------------|----|------|
| Rated capacity | Ah | 1x70 |
| Auxiliary Voltage | V | 12 |
| Exhaust diameter | mm | 50 |
| Exhaust side | | DX |

Weight and Dimensions

| | | |
|--|------------|------------|
| Dimensions (L x w x h) | cm | 175x90x140 |
| Weight with liquids (excluding optionals and fuel) | Kg (+/-3%) | 737 |

Engine

| | | |
|------------------------|------|---------------------------------------|
| Factory | | Perkins |
| Model | | 404A-22G1 |
| Emissions stage | | Stage 0 |
| Speed governor | | Mechanic |
| Radiator | °C | 50 |
| Cooling | Tipo | liquid (water + 50% Paraflu11) |
| Active net power | Kwm | 18,4 |
| Nominal net power | CV | 25 |
| Cycle | Tipo | 4 strokes |
| Injection | Tipo | Indirect |
| Aspiration | Tipo | Natural |
| Numbers of cylinders | N | 4 |
| Cylinders arrangement | | L |
| Bore | mm | 84 |
| Stroke | mm | 100 |
| Total displacement | lt | 2,216 |
| Engine oil features | | 15W40-API CI-4/CH-4 ACEA E5-E7 |
| Total oil capacity | lt | 10,6 |
| Total coolant capacity | lt | 7 |

Alternator

* **May vary based on stock availability. However, a primary brand will be used.**

| | | |
|--------------------------------------|-------|------------------------------|
| Factory | | Stamford |
| Model | | SOL2-G1 |
| Single-phase Range | KVA | 20 |
| Voltage Regulator (voltage accuracy) | +/- % | 1 |
| Poles | N° | 4 |
| Phases | N° | 3+N |
| Standard windings connection | | Star Series |
| Stator/rotor impregnation | | H (Outdoor Temp 40°C) |
| Efficiency | % | 86,8 |
| Engine coupling | | Elastic disk |
| Short circuit current | | >= 300% (3In) |
| Protection degree | IP | 23 |
| Cooling system | | Self ventilating |
| Maxium overspeed | rpm | 2250 |
| Waveform distortion | % | <5 |
| Exciter | | Diode bridge |

Standard operating environmental conditions

| | | |
|---------------------|----|-------------|
| Ambient temperature | °C | 25 |
| Relative Humidity | % | 30 |
| Max altitude | mt | 1000 |

Control Systems on board QLE-B-SC-3F-4P-63-01

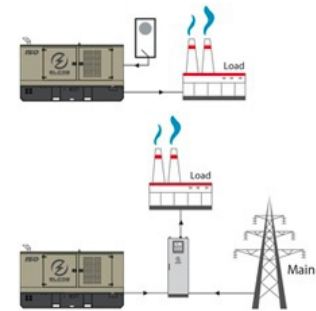

operating scheme - schema di funzionamento

QLE Multifunction panel without switching on board

The QLE command and control panel offers outstanding protection, monitoring and control for small and middle size generator sets. Elcos's control module MC2 Plus offers advanced features to meet the most demanding on-site application. Elcos's control module MC2 Plus is designed to offer an easy user interface. Variant without transfer switch. The panel directly manages the QLTS and QC panels. The output line is protected by a magnetothermic breaker with opening coil. The overload and short-circuit protection is managed by the control board.

Mechanical features

| | | |
|-------------------|----|----|
| Protection degree | IP | 55 |
|-------------------|----|----|

Battery charger

| | | |
|--------------------------------|-----------------|-------------|
| Model | | ELCOS - CB1 |
| Maximum output current | A | 2,5 |
| Output DC voltage (selectable) | V _{dc} | 12-24 |
| Input AC voltage (selectable) | V _{ac} | 220-260 |
| Frequency | Hz | 50-60 |

Data Communication

| | | |
|------------------------|--|-----------------|
| Data connection port | | RS-485 |
| Communication protocol | | Mod-bus RTU-8N1 |

Remotable functions in terminal box

| | |
|--|---|
| GS start | Genset contactor close/open command (1) |
| Mains contactor close/open command (2) | Remote horn - DC output |
| Programmable output - Volt free output | |

(1) Ready to load function (ARS mode without QC or QLTS panel)(1) Genset contactor open and close command (AMF mode with QC or QLTS panel)(2) Mains contactor open and close command (AMF mode with QC or QLTS panel)

Control Module



| | |
|----------------|------------------|
| Model | MC2 Plus |
| Operating mode | AMF - ARS |

Specifics

Applications

Emergency to the Mains
Stand-alone
Construction site/Rental
Self-production

ENGINE MEASURES

Fuel tank level %
Engine oil pressure BAR (1)
Engine Coolant temperature °C (1)
Total run time
Battery voltage
Start-ups counter
Engine speed

ALTERNATOR MEASURES

Generator Voltage L1, L2, L3
Generator Voltage L1-N, L2-N, L3-N
Generator frequency
Generator current L1, L2, L3
Generator Apparent Power kVA
Generator Active Power kW

COMMUNICATION PORTS

Can-bus port
RS485 port with Mod-bus RTU communication
USB port for parameters saving and firmware update

EQUIPMENT

Microprocessor Logic
Back-lit display
Programmable from display
16 event log
Icons management
STOP button
START button
TEST button
Reset alarm button
Alarm mute button

PRE-ALARMS/ ALARMS

Common Alarm
Fuel reserve (pre-alarm)
Low fuel level (alarm)
Charge alternator failed (dinamo)
Low oil pressure (alarm)
Oil sensor failed (alarm)
High coolant temperature (alarm)
Low water level (1)
Water in fuel (1)
Battery undervoltage
Battery overvoltage
GS failure to start
GS failure to stop
Can-bus Failure
No Can-bus communication
Genset overload L1, L2, L3 phases
Genset short circuit
Genset overvoltage
Genset undervoltage
Genset high frequency
Genset low frequency
overspeed
Earth fault (alarm)
Maintenance request
Emergency button pressed
Remote emergency active
Genset negative phase sequence

VISUALIZATIONS ON CONTROL

MODULE/DISPLAY

Pre-alarms
Alarms
Engine measures
Alternator measures
Operating mode
Genset status
Genset contactor status
Glow plugs status

CONTROL MODULE FUNCTIONS

Remote Start and Stop
Manual Start and stop
Emergency stop button on panel board
Remote emergency stop
Remote test on load
Scheduled start-ups
MODBUS commands (Start, Stop, Reset, Test)

Elcos MC2 control module is designed for diesel generating sets. It offers outstanding protection, monitoring and control for small and middle size generator sets.

AAABBB

OPTIONAL

⚙️ Fuel Supply

**O.G-ACO-AT-C3V-01**

External fuel tank connections with 3-way valve for supply from internal or external tank (10/100 kVA)

**O.G-ACO-AT-C3V-AR-01**

Quick coupling connectors with 3-way valve for internal or external fuel tank connection (10/100 kVA)

**O.G-ACO-AT-CI-01**

External tank connections for supply only from external tank (g without tank) GE 10/100

**O.G-ACO-BT-C1750-600**

600 Lt Oversized Fuel Tank on board for SS,RB (10/20 kVA)

**O.G-ACO-GA-01**

Mechanical analogue float for internal fuel tank on board

**O.G-ACO-GA-02**

Electrical analogue float to monitor the external refilling point on board

**O.G-ACO-RE-01**

External refilling point for Gen Sets 10/250 kVA, SS, RB versions

**O.G-ACO-RE-SP-01**

External refilling point with warning light for Gen Sets 10/250 kVA, SS, RB versions

⚙️ Alternator

O.G-ALT-AL-CHBR-01

Different brand alternator (10/40 kVA)

⚙️ Batteries

**O.G-BAT-BAE-01**

Maintenance free high efficiency starter batteries (10/40 kVA)

**O.G-BAT-STB-01**

Battery isolator lockable (10/100 kVA)

⚙️ Canopy

**O.G-COF-AM-01**

Hinges and Doors with tamper-proof device (10/100 kVA)

**O.G-COF-AP-01**













Door opening alarm system (each door)















O.G-COF-C1750-INOX

Additional cost for stainless steel canopy (C1750)

**O.G-COF-CA-C1750**

IP 43 Conveyors for Gen Sets 10/20 kVA - supplied disassembled

| | | |
|---|---------------------------------|--|
|  | O.G-COF-CH-01 | Additional cost for larger canopy C1900 instead of standard C1750 - Dim. cm 190x90x150H - Fuel tank 110 lt |
|  | O.G-COF-DLO-C1750-05KW | Dummy Load 5kW on board for Gen Sets 20 kVA |
|  | O.G-COF-EAF-01 | Frontal air expulsion for Gen Sets 10/20 kVA (C1750) (change the noise level) |
|  | O.G-COF-FP-01 | Door stop (10/100 kVA) |
|  | O.G-COF-IL-01 | Internal LED lighting with micro-switches for Gen Sets 10/250 kVA |
|  | O.G-COF-PV-01 | Lift off doors kit (10/100 kVA) for SS and PRO version |
| | O.G-COF-TRT-MAR-01 | High resistance canopy treatment for corrosive environments for 10/40 kVA (SS, RB Versions) |
|  | O.G-COF-VER-PAR-01 | Canopy custom paint (Grey base-frame) for 10/40 kVA (SS, RB Versions) |
|  | O.G-COF-VER-TOT-01 | Total canopy custom paint for 10/40 kVA (SS, RB Versions) |
| ⚙️ Electrical on board | | |
|  | O.G-USP-MO-01 | Terminal box with tightening terminals inside the cable entry compartment for Gen Sets 10/40 kVA SS Version |
|  | O.G-USP-SW-MOT.0010-0040 | Motorization switch on board machine, integrated in the panel for 10/40 Kva Ge - (for variant +11) |
| | O.Q-QBM-BMIN-230V-01 | Additional price for 230V minimum voltage coil on the modular main switch inside the control panel (check feasibility) |
| | O.Q-QBM-CPI-BEN-01 | Permanent insulation controller for IT networks up to 230V / 400V. BENDER IR423-D4-1. Adjustable threshold 10 ÷ 300 kohm. (2 DIN rail modules - check feasibility) |
| | O.Q-QLE-K-DIF-M3 | Adjustable differential protection only for MC2-PLUS controller for Gen Sets 10/500 kVA (+011 variant) |
|  | O.Q-QLE-QBM-COM-AMF25 | Additional price for QBM COMAP AMF25 panel replacing the standard QLE-A. |
|  | O.Q-QLE-QBM-DSE-7320 | Additional price for QBM DSE7320 panel replacing the standard QLE-A. |
|  | O.Q-QLE-QPE-MC4 | Additional price for QPE-C panel with MC4 replacing the standard QLE-A. |

| | | |
|---|----------------------------|---|
|  | O.Q-QMC-K-DIF-R1 | Adjustable differential protection only for QMC panel for Gen Sets 10/40 kVA (Variant +010 / +011) |
|  | O.Q-QMC-RX8-QMC | Start-stop radio control with max. radius 500 mt indoors and 5 km outdoors (for QMC panel). |
|  | O.Q-QMC-SAS-01 | Auto Start-Stop at load request (QMC panel) |
| | O.Q-QPE-INT-CST-01 | GE main switch STATUS contact wired to terminal board inside the QPE panel on board generator (10 / 40KVA) (no variant +10) |
|  | O.Q-QPE-SAS-02 | Auto Start-Stop at load request (QPE, QLE panels) |
| Engine | | |
|  | O.G-MOT-FC-1 | Dust collector filter - for Gen Sets 10/20 kVA |
|  | O.G-MOT-FSA-1 | Fuel/Water Separator Filter - for Gen Sets 10/20 kVA |
|  | O.G-MOT-K-40C-01 | Engine liquids suitable for -40°C ambient temperature for Gen Sets 10/40 kVA |
|  | O.G-MOT-PO-01 | Oil change pump for Gen Sets 10/100 kVA |
|  | O.G-MOT-RF-01 | Electronic speed governor for Gen Sets 10/40 kVA |
|  | O.G-MOT-SC-AC-EL-01 | Engine pre-heater 230V with thermostat on board for Gen Sets 10/100 kVA + 130/500 PRO version |
|  | O.G-MOT-SC-AC-EL-02 | Super hot engine heater 230V with thermostat on board for Gen Sets 10/100 kVA |
|  | O.G-MOT-SE-PO-LR | Oil pressure level and engine temperature sensors (from 10 to 100kVA) |
|  | O.G-MOT-SRO-AU-12L | Automatic oil refilling system (10/40 kVA) |
| Handling | | |
|  | O.G-MOV-CN-3 | Off-road trailer with 2 pneumatic wheels and tow bar (SS, RB Gen Sets 10/40 kVA) |
|  | O.G-MOV-CO-ST-02 | Roadworthy trailer 80km/h (10/40 kVA), registration excluded. |

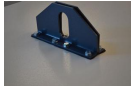
O.G-MOV-GC-BIG-01

Increased central lifting hook with 10x5cm hole (10/250 kVA SS version)

O.G-MOV-KRM-SS-01

Reinforcement kit for mobile installation (dedicated trailers or wheeled machinery) SS Version from 10 to 40 kVA

ATS Panels

QC1.0060A

Separate ATS panel, 4P - 60A contactors (40 kVA 400V - 30 kVA 230V) Dim. 60 x 25 x 80 cm - 47 kg. (ex QC1.040)

QLTS.060A

Wall-mounted ATS switching panel 60A 4P (40 kVA 400V - 20 kVA 230V) Dim. 40 x 16 x 40 cm - 12 kg.

Exhaust

O.G-SCA-CAT-02

Catalytic converter (20 kVA)

O.G-SCA-FAP-K20

Particulate filter (DPF) for Gen Sets 10/20 kVA

O.G-SCA-GF-50

Exhaust bellow with flexible joint including flange and counter flange (10/40 kVA)

O.G-SCA-KS-50

Exhaust flex pipe for drainage (length 3 mt.)

O.G-SCA-PF-01

Spark arrester for Gen Sets 10/40 kVA

O.G-SCA-PR-01

Exhaust pipe protection kit (10/20 kVA) , SS,RB version

Test

MS.CP-LT-01

FAT - Factory Acceptance Test for single Gen Set from 10 to 100 kVA according to our standard procedures in Elcos factory (max 2 hours - max 4 people - max 1 hour of operation)

MS.CP-SP-01

FAT - Factory Acceptance Test for single custom Gen Set from 10 to 100 kVA max 4 operating hours or parallel system up to 4 units for 1 operating hour, in Elcos factory (max 4 hours - max 4 people)

MS.CP-ST-01

FAT - Factory Acceptance Test for single Gen Set from 10 to 100 kVA according to our standard procedures in Elcos factory (max 4 hours - max 4 people - max 2 hour of operation)

MS.RF-ST-01

Noise test report for single Gen Set from 10 to 250 kVA

MS.TV-ST-01

Vibration test on 10 points with certificate for single Gen Set from 10 to 250 kVA

Vari

O.G-VAR-CAT-01

Toolbox for ordinary maintenance.

O.G-VAR-PUN-TER-01

Round earth spike, diam. 20 mm, height 1.5mt, galvanized, complete with clamp and 3m yellow/green cable model FS17 1x35mm² with cable lugs.

O.G-VAR-PUN-TER-02

Cross-shaped earth spike, height 1.5mt, galvanized, complete with clamp and 3m yellow/green cable model FS17 1x35mm² with cable lugs.

O.G-VAR-TPD-01

IP 55 document holder

PRP

Engines of this rating provide unlimited hours of usage in a variable load application. The average load factor should not exceed 70% of the engine's prime power rating with a maximum number of 500 operational hours at 100% prime power rating. An overload capability of 10% is available, however, is limited to a period of 1 in every 12 hours

LTP

Limited-time running power is defined as the maximum power available, under the agreed operating conditions, for which the generating set is capable of delivering for up to 500h of operation per year with the maintenance intervals. The overload is not allowed.

| | | | | | | | | | | |
|--------|--------|--------------|---------------|-------|----------|------|----|--------------|--------------|----------|
| Sheet: | C 1750 | SUPER SILENT | Exhaust side: | Type: | STANDARD | Rev: | 00 | Last Update: | May 03, 2012 | Page 1/2 |
|--------|--------|--------------|---------------|-------|----------|------|----|--------------|--------------|----------|

OVERALL DIMENSIONS [mm]

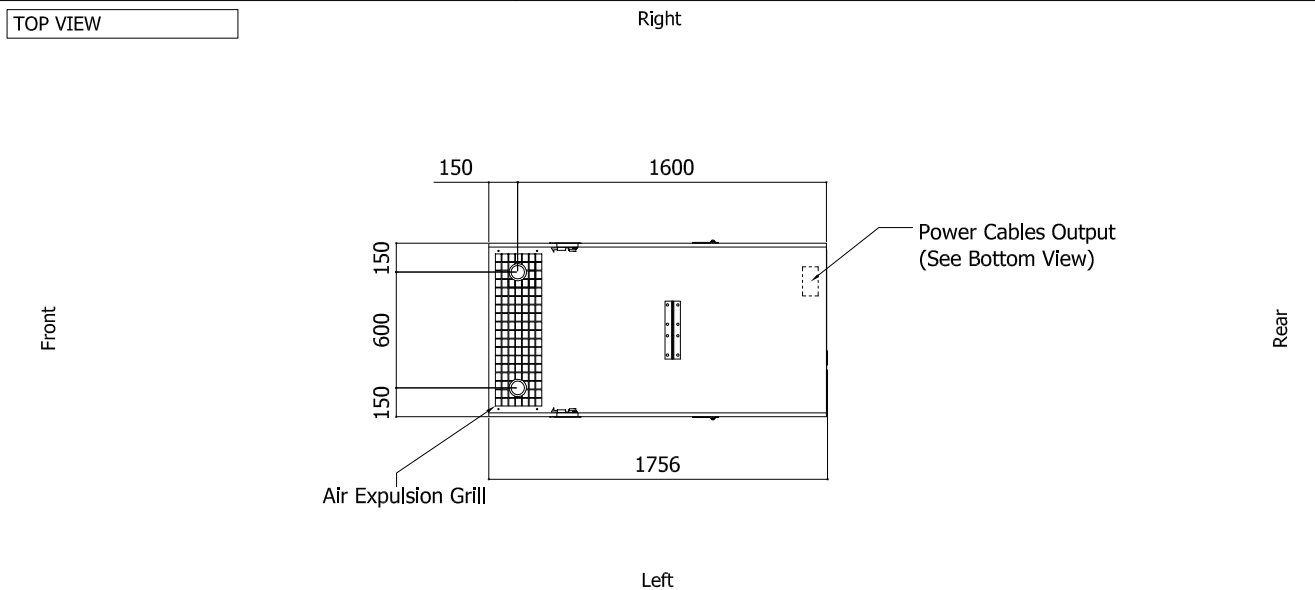
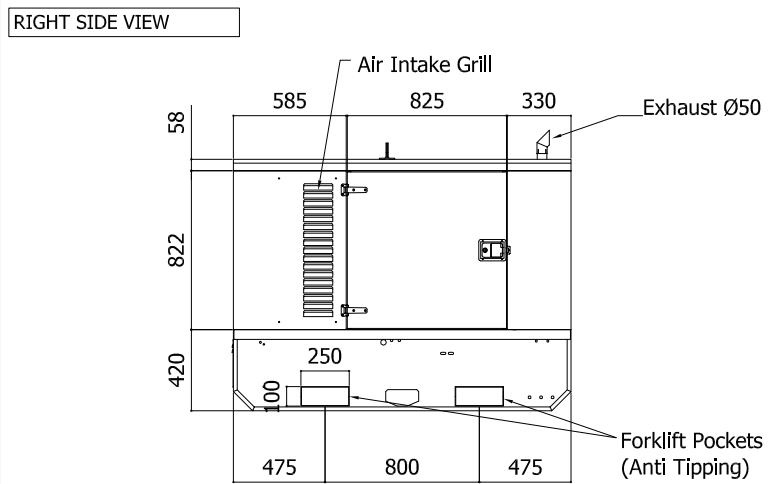
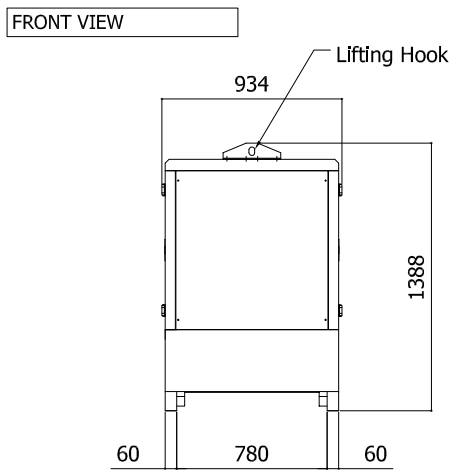
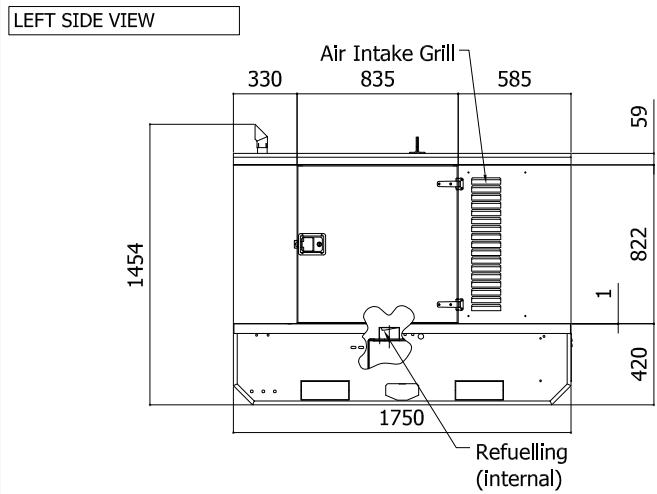
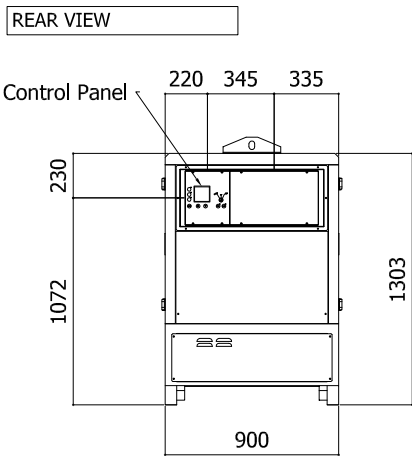

IMPORTANT:

- 1) Form and dimension refer to the generating set on catalogue
- 2) Form and dimension are subject to change in order to update or improve the products
- 3) This document can not be copied or transmitted without ELCOS S.r.l. approval

| | | | | | | | | | | | |
|--------|--------|--------------|---------------|--|-------|----------|------|----|--------------|--------------|----------|
| Sheet: | C 1750 | SUPER SILENT | Exhaust side: | | Type: | STANDARD | Rev: | 00 | Last Update: | May 03, 2012 | Page 2/2 |
|--------|--------|--------------|---------------|--|-------|----------|------|----|--------------|--------------|----------|

BOTTOM VIEW

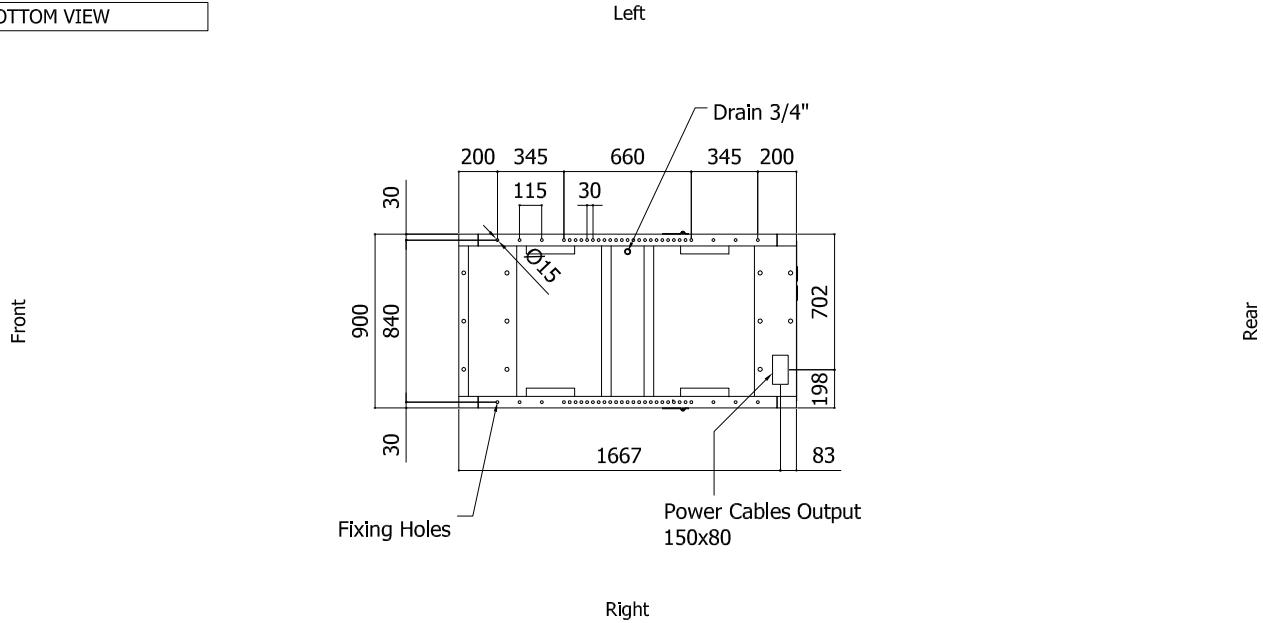

DIMENSIONS WITH OPEN DOORS [mm]

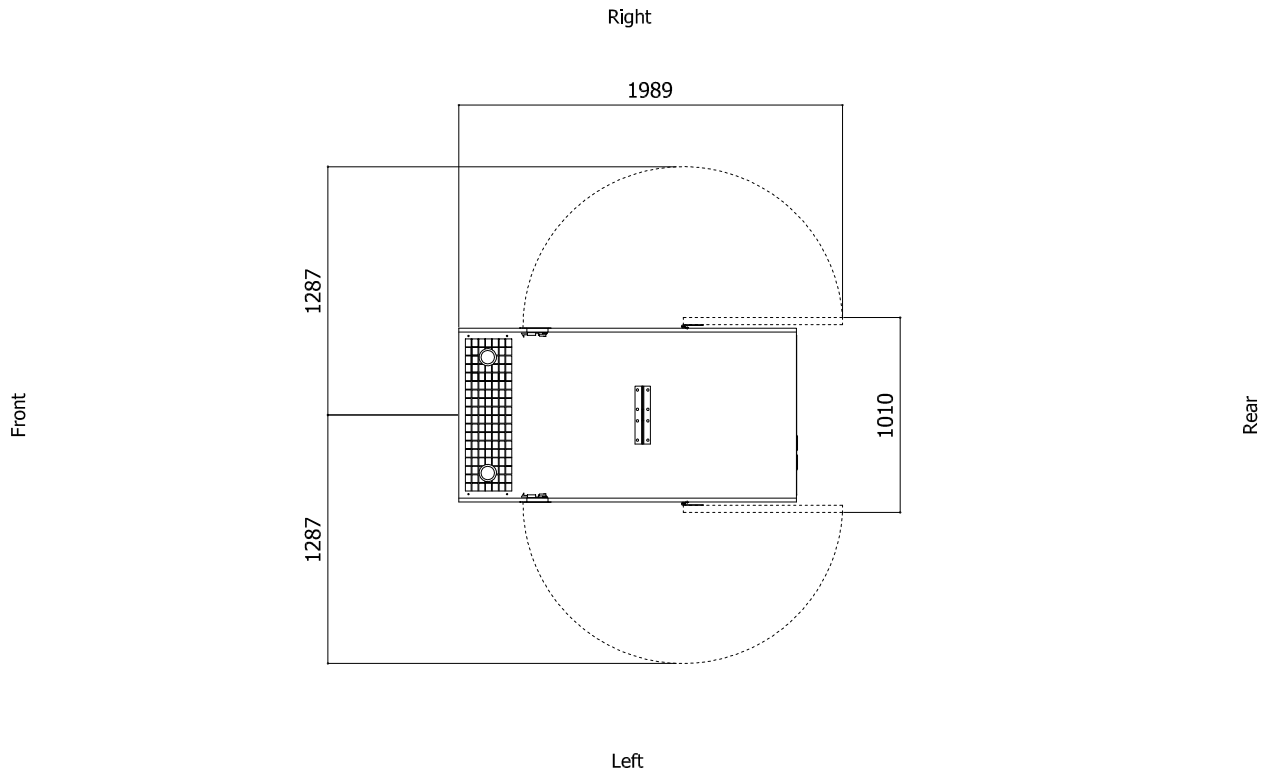

Note: With Lifting-Off Door Solution consider only canopy dimensions.
(Models with "Control Panel" behind rear door will mount a special cover to protect it)

VENTILATION OF THE ROOM

The windows area in the generating set room needs to be (recommended):
Aspiration: 0.26 m²
Expulsion: 0.21m²
ATTENTION: for a correct ventilation the expulsion air and the exhaust gas needs to be conveyed in the open-air

- IMPORTANT:**
- 1) Form and dimension refer to the generating set on catalogue
 - 2) Form and dimension are subject to change in order to update or improve the products
 - 3) This document can not be copied or transmitted without ELCOS S.r.l. approval