



Image for demonstration purposes

 **Generating Set**
SUPERSILENT - Diesel

GE.PK.088/080.SS+011

1500 rpm - Threephase - 50Hz - 400V
Automatic panel without switching on board



Standard equipment

Canopy Soundproofing

Removable soundproof canopy
Painting canopy (RAL) in galvanized sheet steel
Soundproofing with class 1 polyester material
Handles with key lock and automatic closing
Special baffles for air intake and air expulsion
Inspection doors for controls and maintenance

Exhaust

Exhaust rain cap
Insulated exhaust pipes
Internal residential muffler - 35dB(A)

Fuel Supply

Single wall daily tank with bunded base
Automatic shutdown system for low fuel level
Fuel gauge

Handling

Lifting hook integrated into the bearing structure
Base frame with anti-overturning forklift pockets
forkliftable on the short side

Base Frame

Bunded base at 110% of fuel tank capacity
Anti-vibrating mounting pads
Battery compartment externally accessible for easy service

Engine

High coolant temperature and low oil pressure shutdown system
External oil drain points
Engine liquids (oil and antifreeze)
Tropicalized radiator
Rotating parts protection

Alternator

AVR Automatic Voltage Regulator
Impregnation for marine environment
IP23

Panel & connection

Emergency Stop button
Non-Automatic circuit breaker on panel board
RCD with adjustable current and excludible
Tamperproof panel IP55
Cable output from the bottom
IP44 wiring
Start-up battery (pre-charged)
Grounding point

Documentation

CE conformity declaration
User and Maintenance manual
Wirings diagrams

Normatives

All Generating sets are compliant to CE Marking
2014/30/UE Electromagnetic compatibility
2000/14/CE Noise Emission for outdoor use
Factory-designed systems built according to ISO 9001:2015
CEI EN 60204-1:2018 - Electrical equipment of machines

Primary data

General Information

Speed	RPM	1500
Frequency	Hz	50
PRP	KVA	80
PRP - Prime power	KW	64,0
LTP - Standby power	KVA	88
LTP - Standby power	KW	70,4
Standard Voltage	V	400/230
Current	A	115,61
Voltage for current calculation	V	400
COSFI	0,8	0,8

General electrical protection

Circuit-breaker rated current	A	125
Type	Non-Automatic circuit breaker on panel board	
Circuit-breaker poles	N	4P
Optional/notes circuit-breaker	Opening coil	
Additional protection	Adjustable and excludable Differential protection	
Protection device	Control module	
Adjustments tripping set-point (I _d)	mA	30 - 5000
Adjustments tripping time (t)	sec.	0 - 30

Noise level +/- 3dB(A)

LWA	dB(A)	91
Sound pressure level @ 7 mt	dB(A)	66
Sound pressure level @ 1 mt	dB(A)	75

Fuel Consumption

TYPE	Diesel	
Standard Fuel Tank capacity	lt	250
Autonomy @ 75% load	h	18
Fuel consumption at 100% load	lt/h	18,7
Fuel consumption at 75% load	lt/h	14
Fuel consumption at 50% load	lt/h	9,7

General data

Rated capacity	Ah	1x120
Auxiliary Voltage	V	12
Exhaust gas temperature	°C	555
Exhaust gas flow	l/s	208
Combustion air flow	l/s	80
Cooling fan airflow	mc/s	1,5
Exhaust diameter	mm	80
Exhaust side	SX	

Weight and Dimensions

Dimensions (L x w x h)	<i>cm</i>	260x110x168
Weight with liquids (excluding optionals and fuel)	<i>Kg (+/-3%)</i>	1527

⚙️ Engine

Factory		Perkins
Model		1104A-44TG2
Emissions stage		Stage 0
Speed governor		Mechanic
Radiator	°C	50
Cooling	Tipo	liquid (water + 50% Paraflu11)
Active net power	Kwm	71,9
Nominal net power	CV	97,7
Cycle	Tipo	4 strokes
Injection	Tipo	Direct
Aspiration	Tipo	Turbo
Numbers of cylinders	N	4
Cylinders arrangement		L
Bore	mm	105
Stroke	mm	127
Total displacement	lt	4,397
Engine oil features		15W40-API CI-4/CH-4 ACEA E5-E7
Total oil capacity	lt	8
Total coolant capacity	lt	13
ISO 8528-5 class		G3

⚙️ Alternator

*** May vary based on stock availability. However, a primary brand will be used.**

Factory		Stamford
Model		UCI224G
Single-phase Range	KVA	85
Voltage Regulator (voltage accuracy)	+/- %	1
Poles	N°	4
Phases	N°	3+N
Standard windings connection		Star Series
Stator/rotor impregnation		H (Outdoor Temp 40°C)
Efficiency	%	90,2
Engine coupling		Elastic disk
Short circuit current		>= 300% (3In)
Protection degree	IP	23
Cooling system		Self ventilating
Maxium overspeed	rpm	2250
Waveform distortion	%	<5
Exciter		Diode bridge

⚙️ Standard operating environmental conditions

Ambient temperature	°C	25
Relative Humidity	%	30
Max altitude	mt	1000

Control Systems on board QPE-C-SC-3F-4P-160-O2

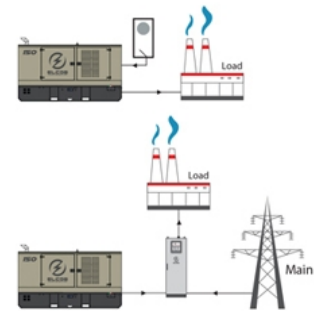

operating scheme - schema di funzionamento

QPE Automatic panel without switching on board

The QPE-C control panel represents the evolution of the panel for the control and management of the gen set. With its microprocessor logic it is able to meet any user requested features. The dual operation mode manual and automatic guarantees to every type of functionality protection, analysis and control of the generating set in order to make the management easy and efficient. Variant without transfer switch on board. ATS panel type QC as optional. The panel manages the QC panels directly or any other ATS panel.

Mechanical features

Protection degree	IP	55
-------------------	----	----

Battery charger

Model		ELCOS - CB1
Maximum output current	A	2,5
Output DC voltage (selectable)	Vdc	12-24
Input AC voltage (selectable)	Vac	220-260
Frequency	Hz	50-60

Data Communication

Data connection port		RS-485
Communication protocol		Mod-bus RTU-8N1

Remotable functions in terminal box

GS start	GS lock
Genset contactor close/open command (1)	Mains contactor close/open command (2)
Common Alarm - DC output	GS test without load
GS start with key in OFF position (Only in MRS mode)	Programmable output - Volt free output

(1) Ready to load function (MRS mode only)(2) AMF mode only

Control Module



Model	MC4
Operating mode	AMF - MRS

Specifics

Applications

Emergency to the Mains
Stand-alone
Construction site/Rental
Self-production

ENGINE MEASURES

Fuel tank level %
Engine oil pressure BAR (1)
Engine Coolant temperature °C (1)
Total run time
Partial run time
Hours to maintenance
Battery voltage
Battery charging voltage
Start-ups counter
Engine speed (2)
Engine Oil temperature (2)
Cooler temperature (2)
Engine oil level (2)
Engine coolant level (2)
Engine coolant pressure (2)
Turbo pressure (2)
Fuel Consumption (2)
Tank autonomy - hrs (5)
Fuel remaining quantity (5)
Fuel used quantity (5)

ALTERNATOR MEASURES

Generator Voltage L1, L2, L3
Generator Voltage L1-N, L2-N, L3-N
Generator frequency
Generator current L1, L2, L3
Generator Apparent Power kVA
Generator Active Power kW
Generator Reactive Power kVAR
Generator accumulated power kWh
Power factor Cosfi

MAINS MEASURES

Mains voltage L1, L2, L3
Mains voltage L1-N, L2-N, L3-N
Mains frequency

COMMUNICATION PORTS

Can-bus port
RS485 port with Mod-bus RTU communication
RS232 port for display connection
USB port for parameters saving and firmware update

EQUIPMENT

Microprocessor Logic
Back-lit display
Programmable from display
16 event log
Multiple display languages
STOP button
START button
TEST button
Reset alarm button
Alarm mute button
Fuel transfer pump activation button
Glow-plug activation button

PRE-ALARMS/ ALARMS

Common Alarm
Fuel reserve (pre-alarm)
Low fuel level (alarm)
Tank overflow
Charge alternator failed (dinamo)
Low oil pressure (pre-alarm) (1)
Low oil pressure (alarm)
Oil sensor failed (alarm)
High coolant temperature (pre-alarm) (1)
High coolant temperature (alarm)
Low coolant temperature (pre-alarm)
Low water level (1)
Water in fuel (1)
Battery undervoltage
Battery overvoltage
GS failure to start
GS failure to stop
Can-bus Failure
No Can-bus communication
Genset overload L1, L2, L3 phases
Genset short circuit
Genset overvoltage
Genset undervoltage
Genset high frequency
Genset low frequency
overspeed
Reverse power
Earth fault (pre-alarm)
Earth fault (alarm)
Block from password
CAN communication Failed
Maintenance request
Emergency button pressed
Remote emergency active
Forced stop
External battery failed
Fuel theft
Genset negative phase sequence
Mains negative phase sequence
Fuel theft protection

VISUALIZATIONS ON CONTROL MODULE/DISPLAY

Pre-alarms
Alarms
Engine measures
Alternator measures
Mains measures
Date and time
Operating mode
Genset status
Mains status
Mains contactor status
Genset contactor status
Digital Input and Output status
Grounding current mA (3)
Grounding current threshold mA (3)
Delay time of differential protection (3)
Glow plugs status

CONTROL MODULE FUNCTIONS

Automatic start and stop when the Mains Fails (7)
Remote Start and Stop
Remote Start and Stop with key in OFF position
Manual Start and stop
Emergency stop button on panel board
Remote emergency stop
Remote lock
Remote test without load
Remote test on load
Scheduled start-ups
MODBUS commands (Start, Stop, Reset, Test)

CONTROL MODULE SPECIAL FUNCTIONS (on demand)

Automatic charging of an external battery
Dummy load (4)
Load shedding (4)
Redundant starter motor management
Fuel monitoring
GS battery Load test
Idle mode
Service phone number indication
Variable speed Generator
Master / Slave mode

- (1) Present with the sensor installed on engine
- (2) Present according to the engine equipment and to the ECU type (ECU - Canbus)
- (3) Present only with the residual current device mounted on genset board
- (4) Present with optional expansion modules
- (5) Present with special function activated
- (6) Only with the optional of the automatic fuel refilling system on board
- (7) Only in AMF mode

AAABBB

OPTIONAL

Fuel Supply

**O.G-ACO-AT-C3V-01**

External fuel tank connections with 3-way valve for supply from internal or external tank (10/100 kVA)

**O.G-ACO-AT-C3V-AR-01**

Quick coupling connectors with 3-way valve for internal or external fuel tank connection (10/100 kVA)

**O.G-ACO-AT-CI-01**

External tank connections for supply only from external tank (g without tank) GE 10/100

**O.G-ACO-BT-C2600-1000**

1000 Lt Oversized Fuel Tank on board for SS, RB (80/100 kVA)

**O.G-ACO-GA-01**

Mechanical analogue float for internal fuel tank on board

**O.G-ACO-GA-02**

Electrical analogue float to monitor the external refilling point on board

**O.G-ACO-RE-01**

External refilling point for Gen Sets 10/250 kVA, SS, RB versions

**O.G-ACO-RE-SP-01**

External refilling point with warning light for Gen Sets 10/250 kVA, SS, RB versions

**O.G-ACO-ST-BG-ES1**

"Easy" automatic fuel refilling system on board, controlled by QPE-C and QLE-B panels

**O.G-ACO-ST-BG-STD**

"Standard" automatic fuel refilling system on board, controlled by QPE-C and QLE-B panels

**O.G-ACO-TK-ST-250**

Partitioned metal tank and reinforced brackets for transport on trailer (SS only)

Alternator

O.G-ALT-AL-CHBR-02

Different brand alternator 50/100 kVA (Check dimensions)

**O.G-ALT-AL-COTE-01**

Temperature control unit up to 4 x PT100 probes for MC4 management

O.G-ALT-ST-ACO-01

Anti-condensation heater 230 V (on Stamford from 80 to 2000 kVA)

**O.G-ALT-ST-AVR-MX321**

Stamford MX321 automatic voltage regulator with PMG (Check dimensions)

**O.G-ALT-ST-AVR-MX341**

Stamford MX341 automatic voltage regulator with PMG (Check dimensions)

O.G-ALT-ST-PT100-1CU

1 x PT100 probe on bearing (80/3000 kVA)

O.G-ALT-ST-PT100-3AV

nr. 3 RTD-PT100 probes on stator windings (80/3000 kVA)

O.G-ALT-ST-PT100-6AV

nr. 3+3 RTD-PT100 probes on stator windings (80/3000 kVA)

O.G-ALT-ST-RIGU-01

Diode Failure Detector (DFD) mounted on the alternator. Alarm contact available into the panel

 **Batteries**

O.G-BAT-BAE-02

Maintenance free high efficiency starter batteries (50/100 kVA)

O.G-BAT-DOB-01

Redundant battery kit for Gen Sets 50/100 kVA

O.G-BAT-STB-01

Battery isolator lockable (10/100 kVA)

 **Canopy**

O.G-COF-AM-01

Hinges and Doors with tamper-proof device (10/100 kVA)

O.G-COF-AP-01

Door opening alarm system (each door)

O.G-COF-C2600-INOX

Additional cost for stainless steel canopy (C2600)

O.G-COF-CA-C2600

IP 43 Conveyors for Gen Sets 80/100 kVA - supplied disassembled

O.G-COF-CH-04

Additional cost for larger canopy C3200 instead of standard C2600 - Dim. cm 320x120x190H - Fuel tank 400lt

O.G-COF-DLO-C2600-25KW

Dummy Load 25kW on board for GE 80/100 kVA

O.G-COF-EAF-03

Frontal air expulsion for Gen Sets 50/100 kVA (C2200/C2600) (change the noise level)

O.G-COF-FP-01

Door stop (10/100 kVA)

O.G-COF-IL-01

Internal LED lighting with micro-switches for Gen Sets 10/250 kVA

O.G-COF-PV-01

Lift off doors kit (10/100 kVA) for SS and PRO version

O.G-COF-TRT-MAR-02

High resistance canopy treatment for corrosive environments for 50/100 kVA (SS, RB Versions)

O.G-COF-VER-PAR-02

Canopy custom paint (Grey base-frame) for 50/100 kVA (SS, RB Versions)

O.G-COF-VER-TOT-02

Total canopy custom paint for 50/100 kVA (SS, RB Versions)

 **Electrical on board**

O.G-USP-125A5P

Output power socket 125A EC 5P (50/80 kVA) for Gen Sets SS Version +011

O.G-USP-MO-02

Terminal box with tightening terminals inside the cable entry compartment for Gen Sets 50/100 kVA SS Version

O.G-USP-MPRB-02

RB module with 5 sockets, 1 plug and power cable access for GE from 50 to 100 KVA SS version (check feasibility)

O.G-USP-SW-MOT.0050-0100

Motorization switch on board machine, integrated in the panel for 50/100 Kva Ge - (for variant +11)

O.Q-QBM-BMIN-230V-02

Additional price for 230V minimum voltage coil on MCCB both on the control panel and on the alternator (check feasibility)

O.Q-QBM-CPI-BEN-01

Permanent insulation controller for IT networks up to 230V / 400V. BENDER IR423-D4-1. Adjustable threshold 10 ÷ 300 kohm. (2 DIN rail modules - check feasibility)

O.Q-QLE-K-DIF-M3

Adjustable differential protection only for MC2-PLUS controller for Gen Sets 10/500 kVA (+011 variant)

O.Q-QMC-K-DIF-R2

Adjustable differential protection only for QMC panel for Gen Sets 50/100 kVA (Variant +010 / +011)

O.Q-QMC-RX8-QMC

Start-stop radio control with max. radius 500 mt indoors and 5 km outdoors (for QMC panel).

O.Q-QMC-SAS-01

Auto Start-Stop at load request (QMC panel)

O.Q-QPE-485.CONV-LAN

Converter 485/LAN for QPE-C, QLE-B panel

O.Q-QPE-485.CONV-USB

Converter 485/USB for QPE panel

O.Q-QPE-DIS-MS-01

















MASTER/SLAVE device for QPE panel

O.Q-QPE-INT-CST-02

STATUS and TRIP contact GE main switch wired to terminal board inside the QPE panel (50 / 100KVA) on board the generator (no variant +10)

O.Q-QPE-K-DIF

Differential protection adjustable for the MC4

	O.Q-QPE-MD-QPE-C	GSM remote management modem for QPE panel
	O.Q-QPE-POT-VOLT	Internal potentiometer for voltage regulation - available only for variant +10/+11
	O.Q-QPE-PR-QPE-C	Remote panel for QPE-C, QLE-B - available only for variant +10/+11
	O.Q-QPE-QBM-COM-AMF25	Option with QBM COMAP AMF25 controller on board instead of QPE
	O.Q-QPE-QBM-DSE-7320	Option with QBM DSE7320 controller on board instead of QPE.
	O.Q-QPE-RIL-16RELE	16-relay module for QPE panel
	O.Q-QPE-RX8-QPE-C	Start-stop radio control with max. radius 500 mt indoors and 5 km outdoors (for QPE panel).
	O.Q-QPE-SAS-02	Auto Start-Stop at load request (QPE, QLE panels)
	O.Q-QPE-SCD-01	Anti-condensation heater inside the panel
	O.Q-QPE-TG-EVO-GPS-2G	Remote management system via LAN/GSM 2G with WEB application and GPS location system
	O.Q-QPE-TG-EVO-GPS-3G	Remote management system via LAN/GSM 3G with WEB application and GPS location system
	O.Q-QPE-TG-QPE-C	Remote management software via LAN for QPE-C, QLE-B panel compatible with Windows XP and 7
 Engine		
	O.G-MOT-FC-4	Dust collector filter - for Gen Sets 80/100 kVA
	O.G-MOT-FSA-4	Fuel/Water Separator Filter - for Gen Sets 80/100 kVA
	O.G-MOT-K-40C-02	Engine liquids suitable for -40°C ambient temperature for Gen Sets 50/100 kVA
	O.G-MOT-PO-01	Oil change pump for Gen Sets 10/100 kVA
	O.G-MOT-RF-02	Electronic speed governor for Gen Sets 50/200 kVA

O.G-MOT-SC-AC-EL-01

Engine pre-heater 230V with thermostat on board for Gen Sets 10/100 kVA + 130/500 PRO version

O.G-MOT-SC-AC-EL-02

Super hot engine heater 230V with thermostat on board for Gen Sets 10/100 kVA

O.G-MOT-SE-LR-01

Radiator coolant level sensor from 10 to 100 Kva

O.G-MOT-SE-PO-LR

Oil pressure level and engine temperature sensors (from 10 to 100kVA)

O.G-MOT-SRO-AU-18L

Automatic oil refilling system (50/100 kVA)

⚙ Handling

O.G-MOV-CN-4

Off-road trailer with 2 pneumatic wheels and tow bar (SS, RB Gen Sets 50/100 kVA)

O.G-MOV-CO-ST-03

Roadworthy trailer 80km/h (50/100 kVA), registration excluded.

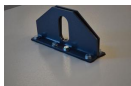
O.G-MOV-GC-BIG-01

Increased central lifting hook with 10x5cm hole (10/250 kVA SS version)

O.G-MOV-KRM-SS-02

Reinforcement kit for mobile installation (dedicated trailers or wheeled machinery) SS Version from 50 to 100 kVA

⚙ ATS Panels

QC1.0125A

Separate ATS panel, 4P - 125A contactors (80 kVA 400V - 50 kVA 230V) Dim. 60 x 25 x 80 cm - 48 kg. (ex QC1.090)

QLTS.160A

Wall-mounted ATS switching panel 160A 4P (110 kVA 400V) Dim. 50 x 20 x 52 cm - 20 kg.

⚙ Exhaust

O.G-SCA-CAT-04

Catalytic converter (80/100 kVA)

O.G-SCA-FAP-K90

Particulate filter (DPF) for Gen Sets 70/80 kVA

O.G-SCA-GF-80

Exhaust bellow with flexible joint including flange and counter flange (50/250 kVA)

O.G-SCA-PF-02

Spark arrestor for Gen Sets 50/100 kVA



O.G-SCA-PR-03

Exhaust pipe protection kit (50/100 kVA) , SS version

Test



MS.CP-LT-01

FAT - Factory Acceptance Test for single Gen Set from 10 to 100 kVA according to our standard procedures in Elcos factory (max 2 hours - max 4 people - max 1 hour of operation)



MS.CP-SP-01

FAT - Factory Acceptance Test for single custom Gen Set from 10 to 100 kVA max 4 operating hours or parallel system up to 4 units for 1 operating hour, in Elcos factory (max 4 hours - max 4 people)

MS.CP-ST-01

FAT - Factory Acceptance Test for single Gen Set from 10 to 100 kVA according to our standard procedures in Elcos factory (max 4 hours - max 4 people - max 2 hour of operation)



MS.RF-ST-01

Noise test report for single Gen Set from 10 to 250 kVA



MS.TV-ST-01

Vibration test on 10 points with certificate for single Gen Set from 10 to 250 kVA

Vari



O.G-VAR-CAT-01

Toolbox for ordinary maintenance.

O.G-VAR-PUN-TER-01

Round earth spike, diam. 20 mm, height 1.5mt, galvanized, complete with clamp and 3m yellow/green cable model FS17 1x35mm² with cable lugs.

O.G-VAR-PUN-TER-02

Cross-shaped earth spike, height 1.5mt, galvanized, complete with clamp and 3m yellow/green cable model FS17 1x35mm² with cable lugs.



O.G-VAR-TPD-01

IP 55 document holder

PRP

Engines of this rating provide unlimited hours of usage in a variable load application. The average load factor should not exceed 70% of the engine's prime power rating with a maximum number of 500 operational hours at 100% prime power rating. An overload capability of 10% is available, however, is limited to a period of 1 in every 12 hours

LTP

Limited-time running power is defined as the maximum power available, under the agreed operating conditions, for which the generating set is capable of delivering for up to 500h of operation per year with the maintenance intervals. The overload is not allowed.

Sheet:	C 2600	SUPER SILENT	Exhaust side:	Type:	STANDARD	Rev:	02	Last Update:	Giu 10, 2015	Page 1/2
--------	--------	--------------	---------------	-------	----------	------	----	--------------	--------------	----------

OVERALL DIMENSIONS [mm]

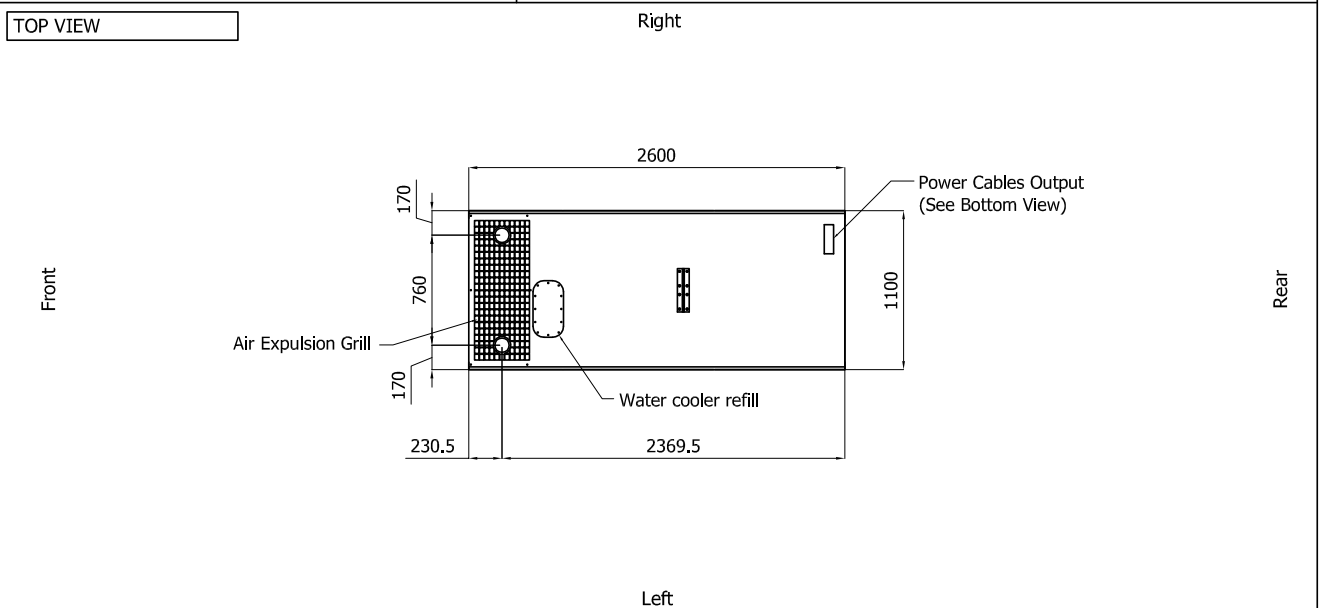
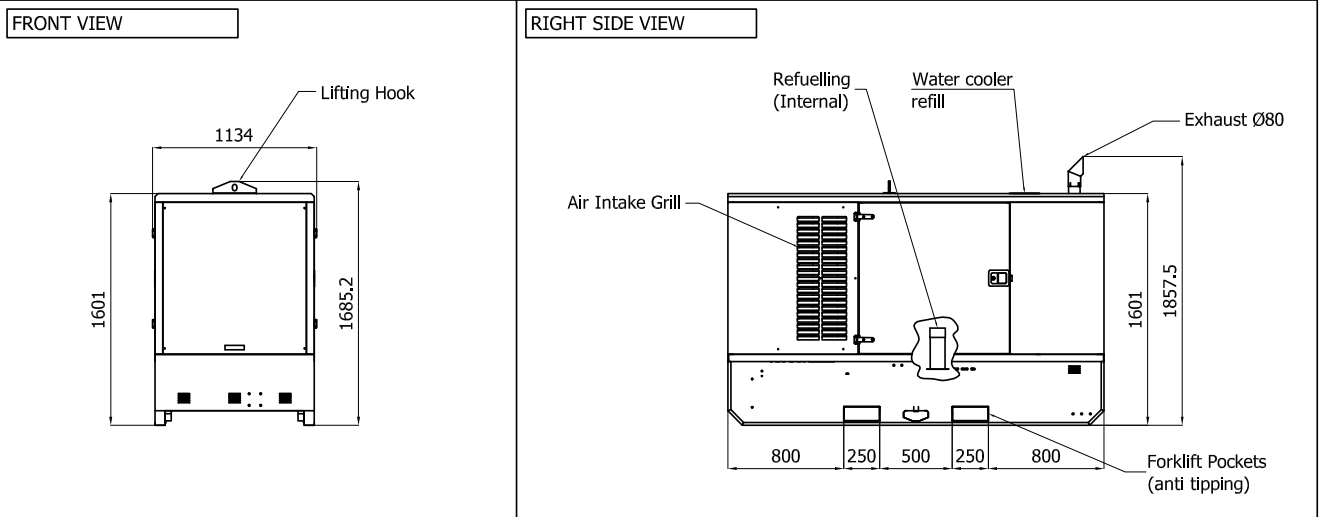
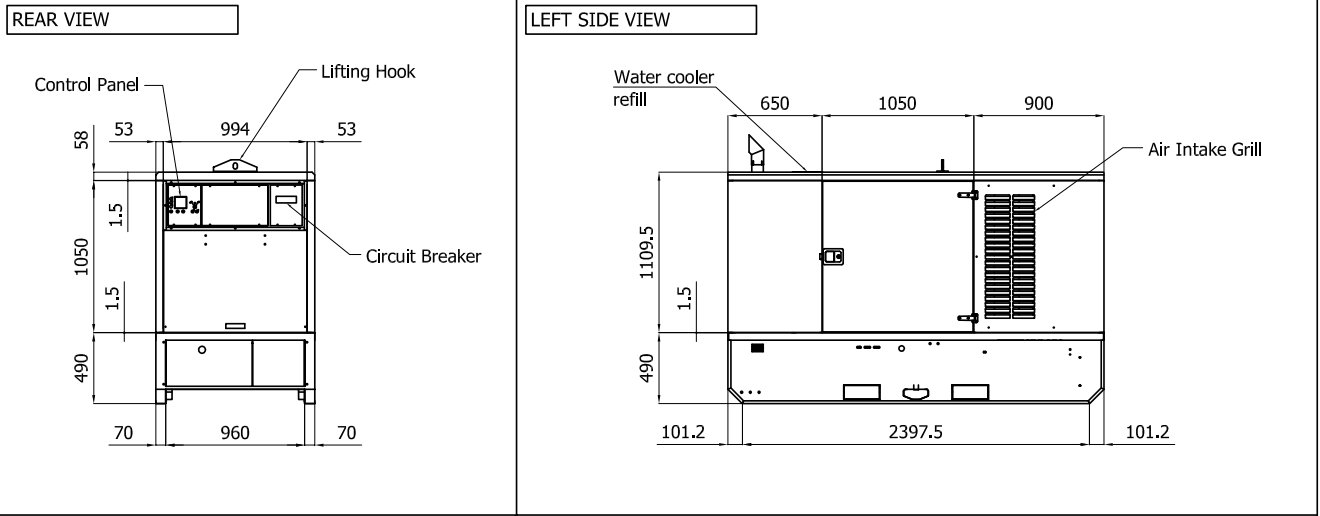

IMPORTANT:

- 1) Form and dimension refer to the generating set on catalogue
- 2) Form and dimension are subject to change in order to update or improve the products
- 3) This document can not be copied or transmitted without ELCOS S.r.l. approval

Sheet:	C 2600	SUPER SILENT	Exhaust side:		Type:	STANDARD	Rev:	02	Last Update:	Giu 10, 2015	Page 2/2
--------	--------	--------------	---------------	--	-------	----------	------	----	--------------	--------------	----------

BOTTOM VIEW

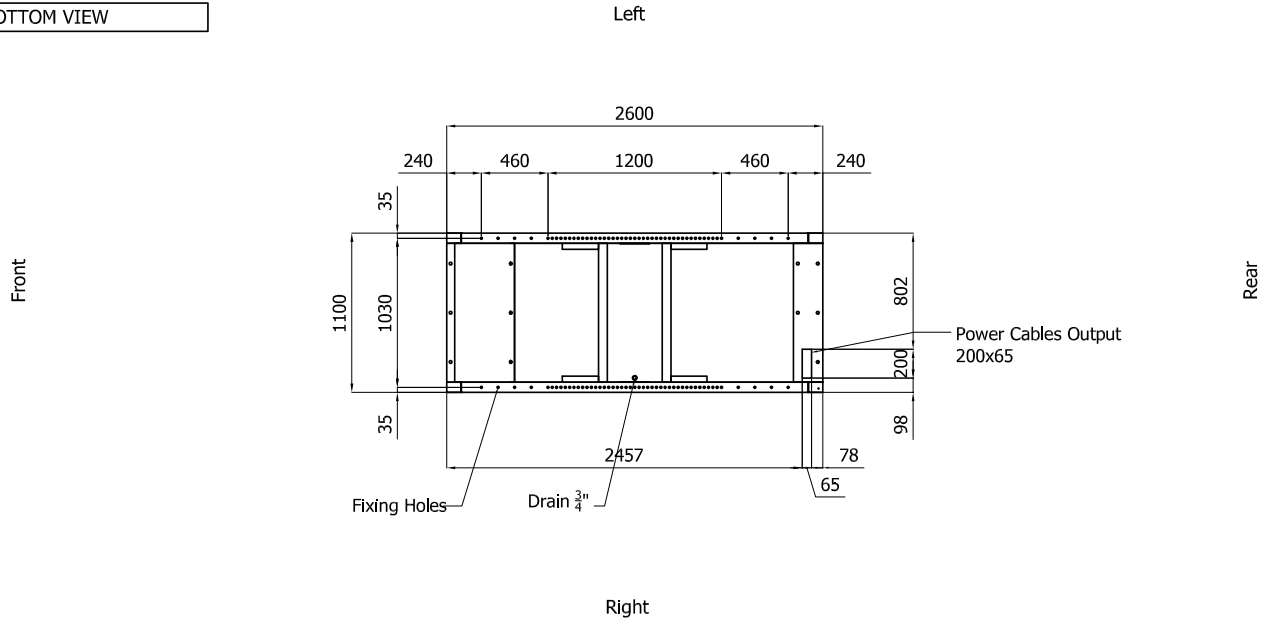

DIMENSIONS WITH OPEN DOORS [mm]

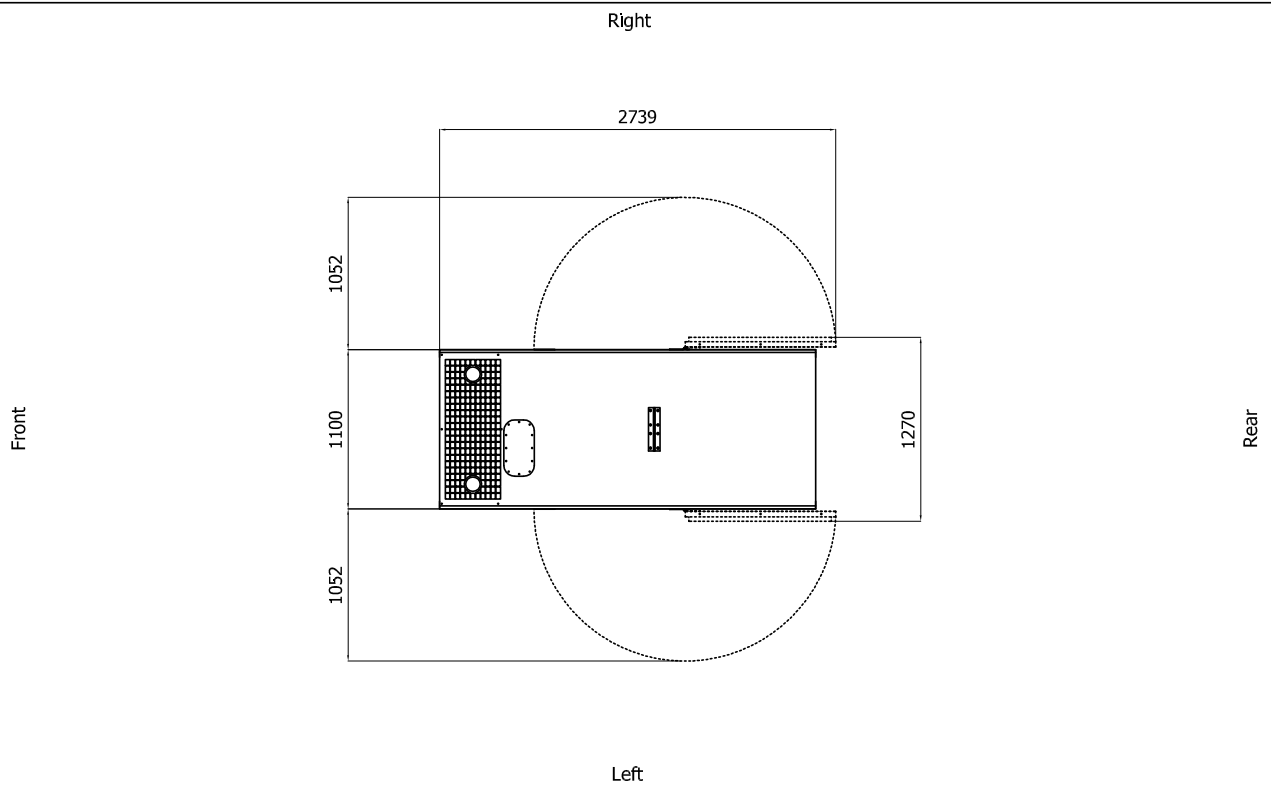

Note: With Lifting-Off Door Solution consider only canopy dimensions.
(Models with "Control Panel" behind rear door will mount a special cover to protect it)

VENTILATION OF THE ROOM

The windows area in the generating set room needs to be (recommended):
Aspiration: 1.00 m2
Expulsion: 0.60 m2
ATTENTION: for a correct ventilation the expulsion air and the exhaust gas needs to be conveyed in the open-air

- IMPORTANT:**
- 1) Form and dimension refer to the generating set on catalogue
 - 2) Form and dimension are subject to change in order to update or improve the products
 - 3) This document can not be copied or trasmitted without ELCOS S.r.l. approval